

SLOVENSKÝ VÝROBCA

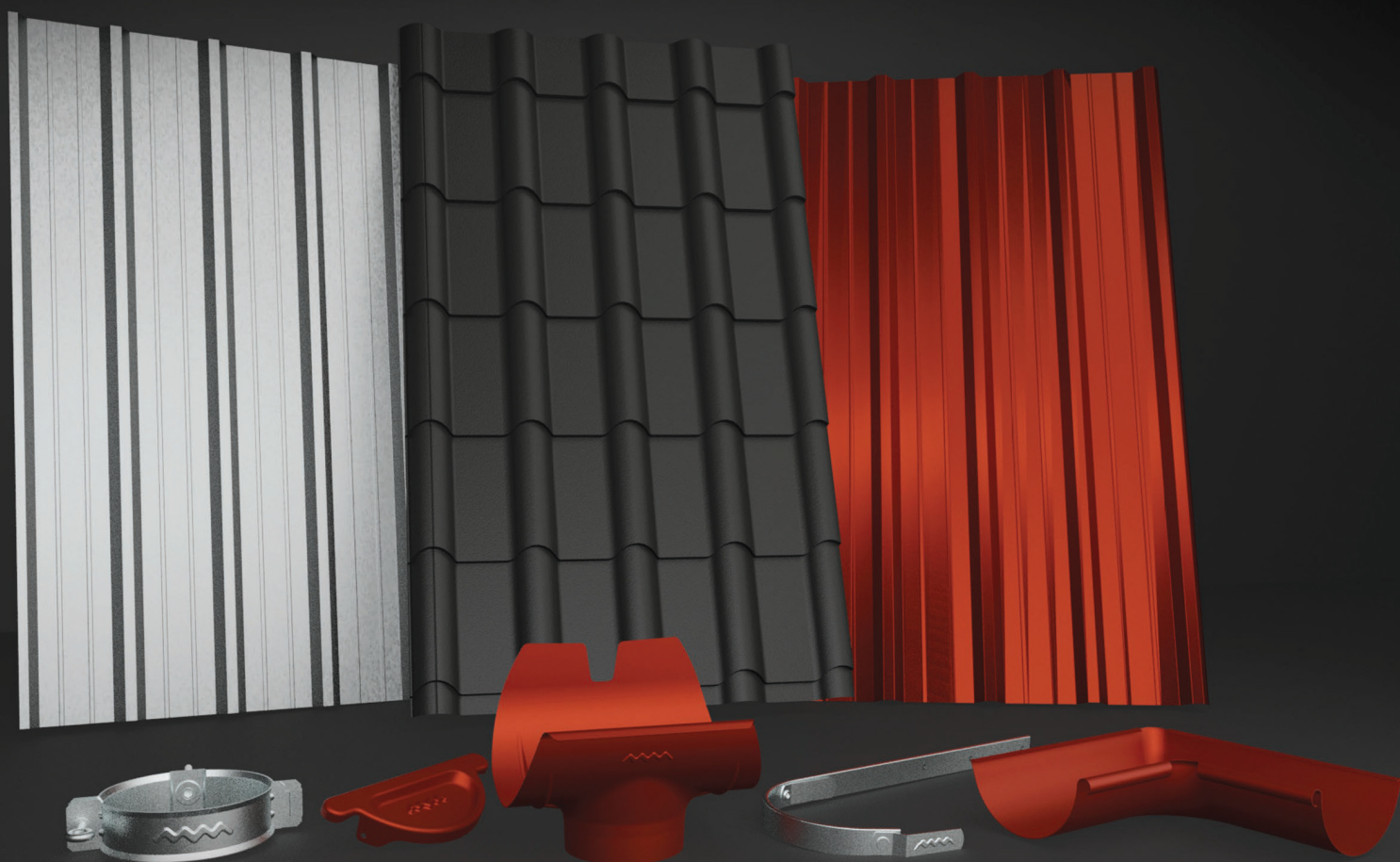

www.maslen.sk











CENNÍK KRYTÍN A STREŠNÝCH DOPLNKOV

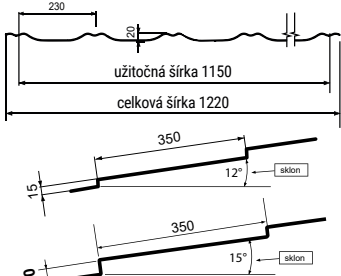

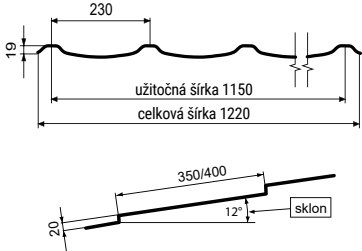
STŘEŠNÉ KRYTINY

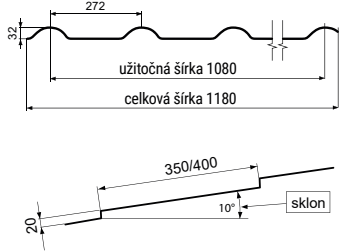

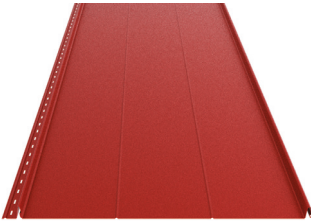
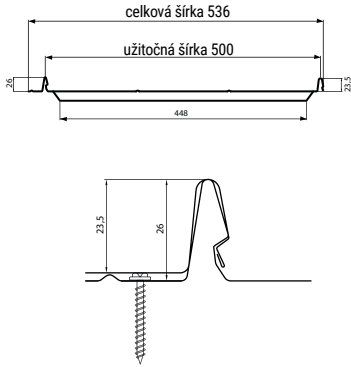
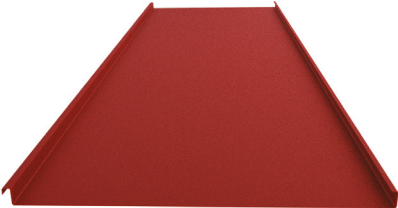
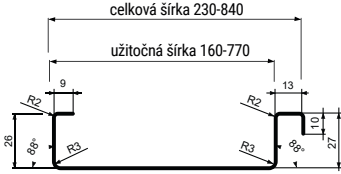



TYP PROFILU	TECHNICKÉ PARAMETRE	POVRCHOVÁ ÚPRAVA / MATERIÁL	CENA BEZ DPH €/ m ²	CENA S DPH €/ m ²
 SYMETRA 	 <p>SYMETRA 30 EXCLUSIVE + 1,00€/m² (1,20€/m² s DPH)</p>	AKCIOVÁ KRYTINA (RAL 3009 / RAL 8017)	8,40	10,08
		Lesklý polyester	9,50	11,40
ALUSYMA		Matný polyester	10,00	12,00
		HB50 MAT - 30R	10,80	12,96
		Hliník 0,70 MAT	17,50	21,00
ŠKRIDPLECH 		AKCIOVÁ KRYTINA (RAL 3009 / RAL 8017)	8,50	10,20
		Lesklý polyester	9,60	11,52
		Matný polyester	10,10	12,12
		HB50 MAT - 30R	10,90	13,08
GAPA 		AKCIOVÁ KRYTINA (RAL 3009 / RAL 8017)	8,60	10,32
		Lesklý polyester	9,70	11,64
ALUGAPA		Matný polyester	10,20	12,24
		HB50 MAT - 30R	11,00	13,20
		Hliník 0,70 MAT	17,60	21,12
 KLIK PANEL 		Pozink hr. 0,5 mm	9,20	11,04
		Pozink hr. 0,6 mm	11,20	13,44
		Lesklý polyester	11,50	13,80
		Matný polyester	11,90	14,28
		HB50 MAT - 30R	12,80	15,36
		Hliník 0,7 mm	22,30	26,76
FALCOVANÁ KRYTINA 		Pozink hr. 0,5 mm	8,20	9,84
		Pozink hr. 0,6 mm	10,20	12,24
		Lesklý polyester	10,50	12,60
		Matný polyester	10,80	12,96
		HB50 MAT - 30R	11,80	14,16
		Hliník 0,7 mm	19,90	23,88

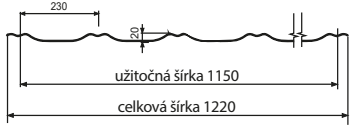
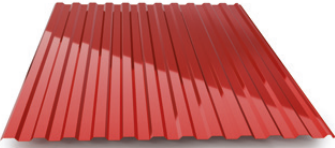

AKCIOVÉ STREŠNÉ KRYTINY

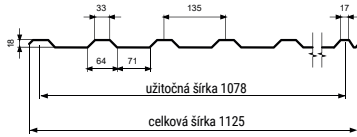

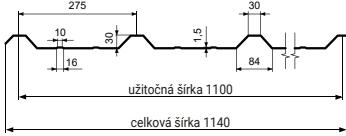
TYP PROFILU	TECHNICKÉ PARAMETRE	POVRCHOVÁ ÚPRAVA	CENA	
TOPDACH 	SKLADOM ROZMER: 2220 x 1220 mm 	FARBY PODĽA DOSTUPNOSTI	CENA BEZ DPH € / 1 ks	CENA S DPH € / 1 ks
			19,50	23,40
TOPDACH NA MIERU			CENA BEZ DPH € / m ²	CENA S DPH € / m ²
			7,40	8,88
UNIDACH 12 	SKLADOM ROZMER: 2000 x 1150 mm 	FARBY PODĽA DOSTUPNOSTI	CENA BEZ DPH € / 1 ks	CENA S DPH € / 1 ks
			16,33	19,60
UNIDACH 12 NA MIERU			CENA BEZ DPH € / m ²	CENA S DPH € / m ²
			7,30	8,76
UNIDACH 18 	SKLADOM ROZMER: 2000 x 1125 mm 	FARBY PODĽA DOSTUPNOSTI	CENA BEZ DPH € / 1 ks	CENA S DPH € / 1 ks
			16,43	19,72
UNIDACH 18 NA MIERU			CENA BEZ DPH € / m ²	CENA S DPH € / m ²
			7,50	9,00
UNIDACH 30 	SKLADOM ROZMER: 2000 x 1140 mm 	FARBY PODĽA DOSTUPNOSTI	CENA BEZ DPH € / 1 ks	CENA S DPH € / 1 ks
			15,73	18,88
UNIDACH 30 NA MIERU			CENA BEZ DPH € / m ²	CENA S DPH € / m ²
			7,10	8,52



TRAPÉZOVÉ PLECHY



TYP TRAPÉZU

TECHNICKÉ PARAMETRE

MATERIÁL

HRŮBKA (mm)

CENA BEZ DPH € / m²

CENA S DPH € / m²

STEPRO

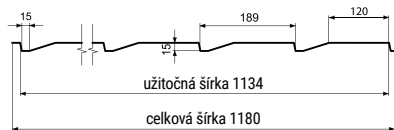

Oceľ (lesklý poly 25µm)

Pozink

Hliník

0,50	8,10	9,72
0,60	10,50	12,60
0,70	12,60	15,12
0,75	11,40	13,68
0,50	6,70	8,04
0,60	8,40	10,08
0,70	9,80	11,76
0,75	9,90	11,88
0,70	14,10	16,92
1,00	20,10	24,12

T 05

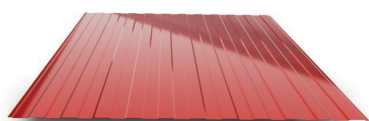

Oceľ (lesklý poly 25µm)

Pozink

Hliník

0,50	7,80	9,36
0,60	9,90	11,88
0,70	11,90	14,28
0,75	11,00	13,20
0,50	6,40	7,68
0,60	8,00	9,60
0,70	9,30	11,16
0,75	9,40	11,28
0,70	13,30	15,96
1,00	19,00	22,80

T 12

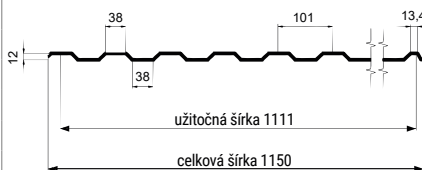
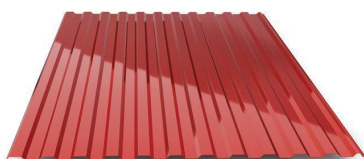

Oceľ (lesklý poly 25µm)

Pozink

Hliník

0,50	8,30	9,96
0,60	10,70	12,84
0,70	12,90	15,48
0,75	11,70	14,04
0,88	13,40	16,08
1,00	15,10	18,12
0,50	6,80	8,16
0,60	8,60	10,32
0,70	10,10	12,12
0,75	10,20	12,24
0,88	11,70	14,04
1,00	13,10	15,72
0,70	14,40	17,28
1,00	20,60	24,72

T 18

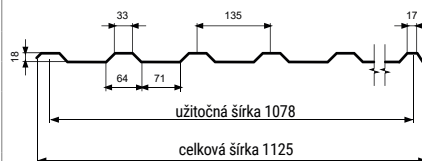

Oceľ (lesklý poly 25µm)

Pozink

Hliník

0,50	8,40	10,08
0,60	11,00	13,20
0,70	13,20	15,84
0,75	12,00	14,40
0,88	13,70	16,44
1,00	15,40	18,48
0,50	7,00	8,40
0,60	8,80	10,56
0,70	10,30	12,36
0,75	10,40	12,48
0,88	12,00	14,40
1,00	13,40	16,08
0,70	14,70	17,64
1,00	21,00	25,20

T 30

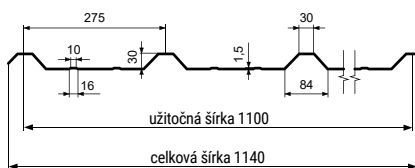

Oceľ (lesklý poly 25µm)

Pozink

Hliník

0,50	8,30	9,96
0,60	10,80	12,96
0,70	13,00	15,60
0,75	11,60	13,92
0,88	13,30	15,96
1,00	15,00	18,00
0,50	6,90	8,28
0,60	8,70	10,44
0,70	10,20	12,24
0,75	10,30	12,36
0,88	11,80	14,16
1,00	13,30	15,96
0,70	14,60	17,52
1,00	20,80	24,96



TRAPÉZOVÉ PLECHY



TYP TRAPÉZU

TECHNICKÉ PARAMETRE

MATERIÁL

HRŮBKBA (mm)

CENA BEZ DPH € / m²

CENA S DPH € / m²

T 35

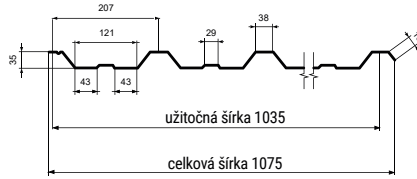

Oceľ
(lesklý poly 25µm)

Pozink

Hliník

0,50	8,80	10,56
0,60	11,50	13,80
0,70	13,80	16,56
0,75	12,50	15,00
0,88	14,40	17,28
1,00	16,10	19,32
0,50	7,30	8,76
0,60	9,20	11,04
0,70	10,80	12,96
0,75	10,90	13,08
0,88	12,50	15,00
1,00	14,00	16,80
0,70	15,40	18,48
1,00	22,00	26,40



SÍNUS 40



ZAKRUŽENÝ PROFIL

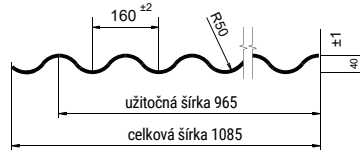

VLNITÝ PROFIL

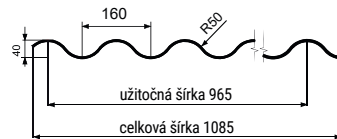

Oceľ
(lesklý poly 25µm)

Pozink

Hliník

0,50	8,80	10,56
0,60	11,40	13,68
0,70	13,70	16,44
0,75	12,40	14,88
0,88	14,20	17,04
1,00	16,00	19,20
1,25	20,00	24,00
0,50	7,30	8,76
0,60	9,20	11,04
0,70	10,80	12,96
0,75	10,90	13,08
0,88	12,60	15,12
1,00	14,10	16,92
0,70	15,30	18,36
1,00	21,80	26,16



T 50

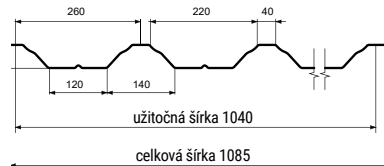
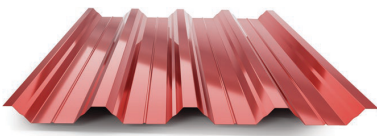

Oceľ
(lesklý poly 25µm)

Pozink

Hliník

0,50	8,80	10,56
0,60	11,40	13,68
0,70	13,70	16,44
0,75	12,40	14,88
0,88	14,20	17,04
1,00	16,00	19,20
1,25	20,00	24,00
0,50	7,30	8,76
0,60	9,20	11,04
0,70	10,80	12,96
0,75	10,90	13,08
0,88	12,60	15,12
1,00	14,10	16,92
0,70	15,50	18,60
1,00	22,10	26,52



T 85

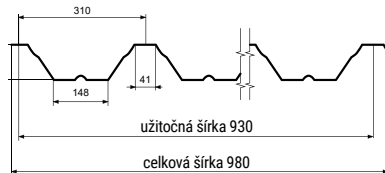
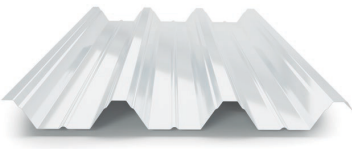

Oceľ
(lesklý poly 25µm)

Pozink

Hliník

0,70	15,10	18,12
0,75	13,70	16,44
0,88	15,70	18,84
1,00	17,70	21,24
1,25	22,20	26,64
0,75	12,00	14,40
0,88	13,90	16,68
1,00	15,50	18,60
0,70	16,90	20,28
1,00	24,20	29,04



T 153

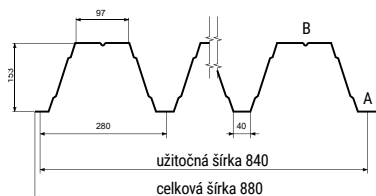
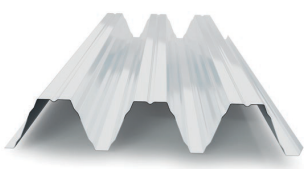

Oceľ
(lesklý poly 25µm)

Malometrážny manipulačný poplatok
do 15m²: 30€ (36€ s DPH)
od 15m² - 30m²: 20€ (24€ s DPH)
pri T153 odber do 60 m²: 30€ (36€ s DPH)

Priplatky: RAL 9006+5%, RAL 3000+10%, zlatý dub +30%,
zlatý dub obojstranne +50%, MAT +5%, HBMAT +15%
Priplatok za zakruženie: SINUS 40: 5€/m² (6€ s DPH)
doprava vybraných profilov sa naceňuje individuálne

0,75	20,40	24,48
0,88	23,90	28,68
1,00	26,20	31,44
1,25	30,80	36,96
1,45	32,80	39,36

KLAMPIARSKÉ DOPLNKY



DRUH DOPLNKU	POVRCH	CENA BEZ DPH €/ 1 ks	CENA S DPH €/ 1 ks	
HREBENÁČ OBLÝ PREMIUM 	2m, r.š. 310	Lesklý polyester	11,40	13,68
		Matný polyester	12,50	15,00
	2m, r.š. 410	HB50 MAT	13,40	16,08
		Lesklý polyester	13,00	15,60
		Matný polyester	14,10	16,92
	HB50 MAT	15,00	18,00	
HREBENÁČ OBLÝ VÝPREDAJ -20% platí do vypredania zásob 	2m, r.š. 310	Lesklý polyester	11,40	13,68
		Matný polyester	12,50	15,00
		HB50 MAT	13,40	16,08
	2m, r.š. 410	Lesklý polyester	14,90	17,88
		Matný polyester	16,60	19,92
		HB50 MAT	17,20	20,64
	Hliník poly MAT	33,80	40,56	
ČELO HREBENÁČA VÝPREDAJ -20% platí do vypredania zásob 	2m, r.š. 310	Lesklý polyester	3,80	4,56
		Matný polyester	4,20	5,04
		HB50 MAT	4,50	5,40
	r.š.410	Hliník poly MAT	8,70	10,44
HREBENÁČ SEDLOVÝ 	2m, r.š. 310	Lesklý polyester	11,40	13,68
		Matný polyester	12,50	15,00
		HB50 MAT	13,40	16,08
	2m, r.š. 410	Lesklý polyester	13,70	16,44
		Matný polyester	15,20	18,24
		HB50 MAT	15,90	19,08
	Hliník poly MAT	31,20	37,44	
UKONČENIE HREBENÁČA OBLÉ 	2m, r.š. 310	Lesklý polyester	8,90	10,68
		Matný polyester	9,50	11,40
		HB50 MAT	10,30	12,36
HREBENÁČ NÁROŽNÝ 	2m, r.š. 310	Lesklý polyester	17,60	21,12
		Matný polyester	19,70	23,64
	r.š.410	HB50 MAT	20,90	25,08
	Hliník poly MAT	39,50	47,40	
ZÁVETERNÁ LIŠTA POD KRYTINU  NA KRYTINU 	2m, r.š. 310	Lesklý polyester	10,20	12,24
		Matný polyester	10,90	13,08
		HB50 MAT	11,40	13,68
		Hliník poly MAT	22,90	27,48
	2m, r.š. 410	Lesklý polyester	11,40	13,68
		Matný polyester	12,10	14,52
		HB50 MAT	12,70	15,24
		Hliník poly MAT	26,40	31,68
BOČNÉ LEMOVANIE PODKRYTINU  NADKRYTINU 	2m, r.š. 310	Lesklý polyester	10,70	12,84
		Matný polyester	11,40	13,68
		HB50 MAT	12,10	14,52
		Hliník poly MAT	23,60	28,32
ODKVAPOVÉ LEMOVANIE 	2m, r.š. 250	Lesklý polyester	7,30	8,76
		Matný polyester	8,00	9,60
		HB50 MAT	8,40	10,08
		Hliník poly MAT	16,50	19,80
ODKVAPOVÉ LEMOVANIE POD HYDROIZOLÁCIU 	2m, r.š. 125	UNI	3,30	3,96
		Lesklý polyester	3,90	4,68
		Matný polyester	4,30	5,16
		HB50 MAT	4,50	5,40
		Hliník poly MAT	8,80	10,56
ÚŽĽABIE SO STREDOVÝM ROZRAŽAČOM 	2m, r.š. 500 2m, r.š. 625	Lesklý polyester	15,70	18,84
		Matný polyester	17,10	20,52
		HB50 MAT	18,00	21,60
		Hliník poly MAT	34,10	40,92
PRECHOD RÔZNYCH TYPOV KRYTÍN  PRECHOD RÔZNYCH SKLONOV 	2m, r.š. 310	Lesklý polyester	10,70	12,84
		Matný polyester	11,40	13,68
		HB50 MAT	12,10	14,52
		Hliník poly MAT	23,60	28,32
LEMOVANIE OKOLO KOMÍNA 		Lesklý polyester	20,00	24,00
		Matný polyester	20,60	24,72
		HB50 MAT	21,30	25,56
		Hliník poly MAT	39,80	47,76

DOPLNKY K FALCOVANEJ KRYTINE A KLIK PANELU

DRUH DOPLNKU	POVRCHOVÁ ÚPRAVA	CENA BEZ DPH €/ 1 ks	CENA S DPH €/ 1 ks	
HREBENÁČ NA FALC A KLIK PANEL 	2m, r.š. 310	Pozink	11,30	13,56
		Lesklý polyester	12,50	15,00
		Matný polyester	13,50	16,20
		HB50 MAR - 30R	14,40	17,28
		Hliník poly MAT	28,40	34,08
ZÁVETERNÁ LIŠTA NA KLIK PANEL 	2m, r.š. 312	Pozink	10,70	12,84
		Lesklý polyester	11,80	14,16
		Matný polyester	12,60	15,12
		HB50 MAR - 30R	13,30	15,96
		Hliník poly MAT	26,80	32,16
BOČNÉ LEMOVANIE NA KLIK PANEL 	2m, r.š. 310	Pozink	10,50	12,60
		Lesklý polyester	11,40	13,68
		Matný polyester	12,50	15,00
		HB50 MAR - 30R	13,00	15,60
		Hliník poly MAT	26,20	31,44
ODKVAPOVÉ LEMOVANIE NA FALC A KLIK PANEL 	2m, r.š. 310	Pozink	10,30	12,36
		Lesklý polyester	11,20	13,44
		Matný polyester	12,00	14,40
		HB50 MAR - 30R	12,80	15,36
		Hliník poly MAT	24,60	29,52
ZÁVETERNÁ LIŠTA NA FALC. KRYTINU 	2m, r.š. 310	Pozink	8,40	10,08
		Lesklý polyester	9,20	11,04
		Matný polyester	10,00	12,00
		HB50 MAR - 30R	10,50	12,60
		Hliník poly MAT	19,70	23,64
DRUH DOPLNKU	UMIESTNENIE	CENA BEZ DPH €/ 1 ks	CENA S DPH €/ 1 ks	
VETRACIA LIŠTA HREBENÁČA 	na KLIK PANEL - Z 0,48 m	2,60	3,12	
	na falcovanú krytinu - Z 0,53 m	2,70	3,24	
	AL 0,53 m	4,00	4,80	
KOTVIACI PROFIL NAPOJENIA r.š. 70mm L=480mm 	oceľová krytina KLIK panel	1,10	1,32	
	hliníková krytina KLIK panel	1,50	1,80	

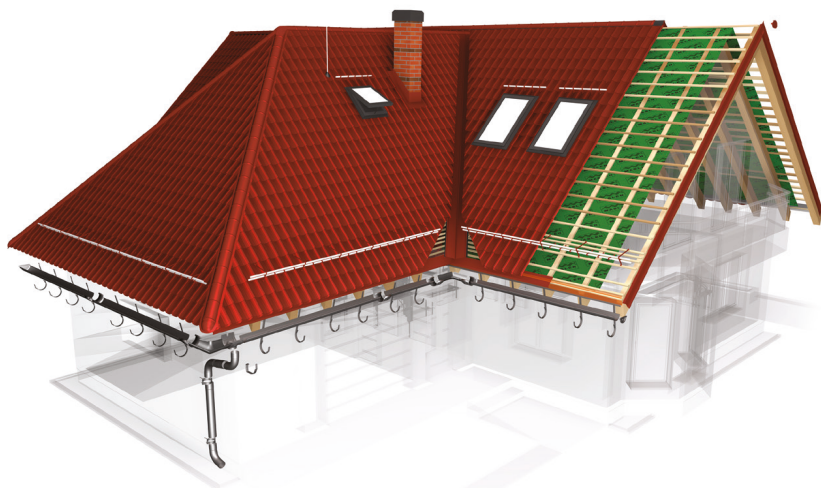

PRÍPLATKY:

- RAL 9006 + 5 %
- RAL 3000 + 10 %
- zlatý dub + 30%
- zlatý dub - obojstranne +50%

Doplňky k pozinku a aluzinku - 10%
ochranná fólia na lesklé plechy: 0,50€/m² (0,60 € s DPH)
ochranná fólia na matné plechy: 0,60€/m² (0,72 € s DPH)



DRUH ZVITKU	POVRCH	ROZMER	MJ	CENA BEZ DPH € / 1 ks	CENA S DPH € / 1ks
TABUĽOVÝ PLECH (bez ochrannej fólie) hrúbka 0,5 mm	Lesklý polyester	1250x2000m	ks	20,00	24,00
	Matný polyester	1250x2000m	ks	21	25,20
	HB50 MAT	1250x2000m	ks	23,00	27,60
	Hliník poly MAT	1250x2000m	ks	40,00	48,00

DRUH ZVITKU	POVRCH	ROZMER	MJ	CENA BEZ DPH € / m ²	CENA S DPH € / m ²
ZVITKOVÝ PLECH OCEL (bez ochrannej fólie) hrúbka 1,5 mm - len v RAL 9002, 15 µm	Lesklý polyester	0,50x1250mm	m ²	8,00	9,60
	Matný polyester	0,50x1250mm	m ²	8,40	10,08
	HB50 MAT	0,50x1250mm	m ²	9,20	11,04
	Lesklý polyester	0,60x1250mm	m ²	10,30	12,36
	Lesklý polyester	0,70x1250mm	m ²	12,80	15,36
	Lesklý polyester	0,75x1250mm	m ²	12,90	15,48
	Lesklý polyester	0,88x1250mm	m ²	14,70	17,64
	Lesklý polyester	1,00x1250mm	m ²	15,10	18,12
	Lesklý polyester	1,25x1250mm	m ²	18,30	21,96

DRUH ZVITKU	POVRCH	ROZMER	MJ	CENA BEZ DPH € / m ²	CENA S DPH € / m ²
ZVITKOVÝ PLECH HLINÍK (bez ochrannej fólie)	Matný polyester	0,70x1250mm	m ²	16,00	19,20
	Lesklý RAL 9010	1,00x1250mm	m ²	27,00	32,40

DRUH ZVITKU	POVRCH	ROZMER	MJ	CENA BEZ DPH € / m ²	CENA S DPH € / m ²
ZVITKOVÝ PLECH POZINK	S220GD	0,50x1250mm	m ²	6,80	8,16
	DX51	0,55x1000mm	m ²	9,50	11,40
	S250GD	0,60x1250mm	m ²	7,30	8,76
	S250GD	0,75x1250mm	m ²	9,50	11,40
	S250GD	0,88x1250mm	m ²	10,80	12,96
	S250GD	1,00x1250mm	m ²	12,60	15,12

SNEHOVÉ ZÁBRANY FALCOVANÁ KRYTINA KLIK PANEL	POVRCH	MJ	CENA BEZDPH € / 1 ks	CENA S DPH € / 1ks
SVORKA JEDNODIEROVÁ - FALC 2 príložky + 2 zaisťovacie skrutky M12x30	hliník	ks	5,20	6,24
	farba	ks	9,40	11,28
NADSTAVBA NA DRUHÚ RÚRU - FALC montuje sa na svorku jednodierovú	hliník	ks	3,10	3,72
	farba	ks	5,10	6,12
SVORKA DVOJRÚROVÁ NA KLIK PANEL	farba	ks	18,00	21,60
DORAZ PROTI POHYBU RÚRY	hliník	ks	2,70	3,24
	farba	ks	3,70	4,44
TYČ DO SNEHOVEJ ZÁBRANY (3M A 6M)	hliník	bm	5,60	6,72
SPOJKA RÚRY	hliník	ks	4,00	4,80
KRYTKA RÚRY	plast	ks	0,30	0,36

DRUH	POVRCH	CENA BEZ DPH € / bm	CENA S DPH € / bm
PLOTOVÁ LAMELA hrúbka 0,5 mm	Aluzinok / Pozink	1,80	2,16
	Lesklý polyester	1,80	2,16
	Matný polyester	1,90	2,28
	HB50 MAT	2,10	2,52
	obojsstranne lakované	2,30	2,76
TRHACÍ NIT 4 x 8	Lakovany	0,07	0,08

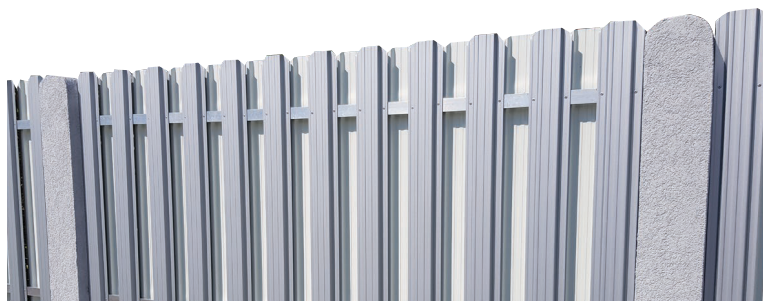

PRÍPLATKY:

- RAL 9006 + 5 %
- RAL 3000 + 10 %
- zlatý dub + 30 %
- zlatý dub - obojsstranne + 50 %
- ochranná fólia na lesklé plechy: 0,50€/m² (0,60 € s DPH)
- ochranná fólia na matné plechy: 0,60€/m² (0,72 € s DPH)

Priečne delenie: +0,06 € / m² (0,072 € s DPH)

Pozdĺžne delenie: 0,50€ / bm (0,60 € s DPH) Ohýbanie: +0,60 € / bm (0,72 € s DPH)

SNEHOVÉ ZÁBRANY NA KRYTINY A TRAPÉZOVÉ PLECHY	POVRCH	MJ	CENA BEZDPH € / 1 ks	CENA S DPH € / 1ks
ROZBERAČ SNEHOVEJ ZÁBRANY	farba	ks	2,90	3,48
VZPERA SNEHOVEJ ZÁBRANY	farba	ks	3,00	3,60
DRŽIAK SNEHOVEJ ZÁBRANY 350 - jednodierový	farba	ks	5,30	6,36
DRŽIAK SNEHOVEJ ZÁBRANY 350 - dvojdiery	farba	ks	6,00	7,20
TYČ DO SNEHOVEJ ZÁBRANY (3 m A 6 m)	prírodný hliník	ks	5,60	6,72
SPOJKA RÚRY	farba	ks	4,00	4,80
KRYTKA RÚRY	farba	ks	0,30	0,36
SNEHOVÁ ZÁBRANA NA VRCH VLNY S BUTYL TESNENÍM	Lesklý polyester	ks	1,90	2,28
	Matný polyester	ks	2,00	2,40
	HB50 MAT	ks	2,10	2,52
	Hliník poly MAT	ks	5,60	6,72
SNEHOVÁ ZÁBRANA 2m S VÝSTUHOU	Lesklý polyester	ks	14,50	17,40
	Matný polyester	ks	16,00	19,20
	HB50 MAT	ks	16,80	20,16
	Hliník poly MAT	ks	37,00	44,40

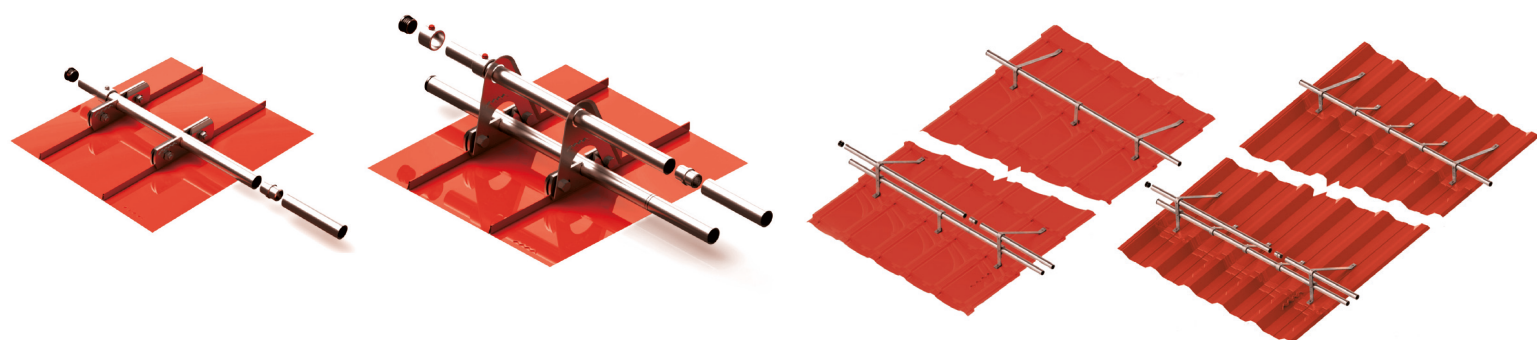



STREŠNÉ PRÍSLUŠENSTVO



DRUH PRÍSLUŠENSTVA	ROZMERY	MJ	CENA € / 1ks BEZ DPH	CENA € / 1ks S DPH	TESNIACI PÁS	VRHCNÝ SPODNÝ	MJ	CENA € / 1ks BEZ DPH	CENA € / 1ks S DPH	
KONTAKTNÁ FÓLIA (polopriepustná)	100 g	m ²	0,69	0,83	ŠKRIDLPECH GAPA SYMETRA	vrchný / spodný	ks	2,45	2,94	
	140 g	m ²	0,95	1,14						
	samolep. 140 g	m ²	1,15	1,38						
	230 g	m ²	2,67	3,20						
	samolep. 230 g	m ²	2,86	3,43						
OCHRANNÁ VETRACIA MRIEŽKA plastová - hnedá, čierna, tehlová hliníková - hnedá, šedá, tehlová	plast 50 mm	bm	0,47	0,56	SÍNUS	vrchný / spodný	ks	2,20	2,64	
	plast 80 mm	bm	0,56	0,67						
	plast 100 mm	bm	0,58	0,70						
	hliník 100 mm	bm	2,80	3,36						
SAMOLEPIACA PÁSKA pod kontralatu - jednostranná	5 cm x 30 bm	bal	9,20	11,04	T12	vrchný + spodný	pár	1,26	1,51	
SAMOLEPIACA PÁSKA na fóliu - jednostranná	5 cm x 25 bm	bal	11,50	13,80	T18	vrchný + spodný	pár	1,27	1,52	
SAMOLEPIACA PÁSKA na fóliu - obojstranná	5 cm x 25 bm	bal	10,50	12,60	T30	vrchný + spodný	pár	1,80	2,16	
SAMOLEPIACA PÁSKA SUPER PRO na fóliu - jednostranná	5 cm x 25 bm	bal	23,68	28,42	T35	vrchný + spodný	pár	1,60	1,92	
BUTYLOVÁ TESNIAČA PÁSKA	1,5 cm x 30 bm	bm	0,42	0,50	T50	vrchný + spodný	pár	1,92	2,30	
VETRACÍ HREBEŇ	100 cm	ks	0,49	0,59	T85	vrchný / spodný	ks	2,75	3,30	
TESNIAČI PÁS ÚŤLABIA - samolepiaca	100 cm	ks	0,87	1,04	vrchný / spodný	ks	4,45	5,34		
ASFALTOVÝ PÁS AL - okolo komína	30 cm	bm	11,35	13,62	vrchný / spodný	ks	5,80	6,96		
ODVETRACÍ PÁS HREBEŇA	MASLEN	bm	2,25	2,70	vrchný / spodný	ks	10,40	12,48		
STREŠNÝ VÝLEZ VELUX VLT 025	45 x 55 cm	ks	92,50	111,00	PRESVETLOVACÍ PÁS SKLOLAMINÁT š x d odber min. dĺžka 1m					
					ROZMER MJ Cena €/1 m ² bez DPH Cena €/1 m ² s DPH					
STREŠNÝ VÝLEZ VELUX VLT 029	45 x 73 cm	ks	110,83	133,00	PRESVETLOVACÍ PÁS POLYKARBONÁT š x d odber min. dĺžka 6m					
					ROZMER MJ Cena €/1 m ² bez DPH Cena €/1 m ² s DPH					
OPRavný LAK GUNNEBO	20 ml	ks	4,60	5,52	T18	1135 x 6000	m ²	17,50	21,00	
OPRavný SPREJ GUNNEBO	400 ml	ks	10,99	13,19	T35	1100 x 6000	m ²	17,90	21,48	
KONCOVKA PARAPETY 300	300 mm	ks	0,81	0,97	T50	1110 x 6000	m ²	18,70	22,44	
STREŠNÉ LATY	50 x 35 mm	bm	0,70	0,84	TYP SKRUTIEK					
PRESTUPOVÁ MANŽETA (nedelená)	č.3 - 6 - 146 mm	ks	20,00	24,00	ROZMER MJ Cena €/1 ks bez DPH Cena €/1 ks s DPH					
	č.4 - 70 - 178 mm	ks	26,00	31,20	FARMÁRSKE SKRUTKY					
	č.5 - 102 - 210 mm	ks	29,00	34,80	pozinkované do dreva					
	č.6 - 121 - 254 mm	ks	32,00	38,40	4,80 x 20 mm ks 0,05 0,06					
	č.7 - 140 - 292 mm	ks	47,00	56,40	4,80 x 35 mm ks 0,05 0,06					
	č.8 - 171 - 343 mm	ks	62,00	74,40	4,80 x 60 mm ks 0,16 0,19					
PRESTUPOVÁ MANŽETA (delená)	15 - 105 mm	ks	29,00	34,80	4,80 x 80 mm ks 0,17 0,20					
	100 - 240 mm	ks	49,00	58,80	FARMÁRSKE SKRUTKY					
PRESTUPOVÁ MANŽETA	MF MUF 1	6 - 70 mm	ks	21,00	25,20	pozinkované do ocelevej konštrukcie				
	MF MUF 3	6 - 146 mm	ks	22,00	26,40	5,5 x 19 mm ks 0,12 0,14				
	MF MUF 5	102 - 210 mm	ks	34,00	40,80	5,5 x 35 mm ks 0,14 0,17				
	MF SOLAR a MP	19 - 253 mm	ks	23,00	27,60	5,5 x 32 mm ks 0,16 0,19				
Doplňky ku falcovanej krytine a klikpanelu					MJ	Cena €/1 ks bez DPH	Cena €/1 ks s DPH			
Príponka 25 pevná, nerezová					ks	0,17	0,20	FARMÁRSKE SKRUTKY		
Príponka 25 pohyblivá, nerezová					ks	0,24	0,29	oceľové lakované do dreva		
Príponka 28 pevná, nerezová					ks	0,18	0,22	4,80 x 20 mm ks 0,06 0,07		
Príponka 28 pohyblivá, nerezová					ks	0,29	0,35	4,80 x 35 mm ks 0,06 0,07		
Skrutka ku KLIK panelu 4,2 x 25 mm					ks	0,03	0,04	4,80 x 60 mm ks 0,18 0,22		
Skrutka so zápusťnou hlavou Zn 4x30 (bal 500ks)					100 ks	3,90	4,68	4,80 x 80 mm ks 0,19 0,23		
Fólia pod falcovanú krytinu 1,50 x 25m					m ²	4,20	5,04	5,5 x 19 mm ks 0,14 0,17		
Expanzná páska					25 bm	9,00	10,80	5,5 x 24 mm ks 0,15 0,18		
Akustická páska pod Falc a KLIK 5mm x 90mm x 30bm					ks	13,00	15,60	5,5 x 32 mm ks 0,16 0,19		





ODKVAPOVÝ SYSTÉM



DRUH PRÍSLUŠENSTVA	*	MJ	ROZMER cm	FAREBNÝ		POZINKOVANÝ		ALUZINKOVÝ *VÝPREDAJ-40%		
				CENA € / 1ks		cena € / 1ks		cena € / 1ks		
				bez dph	s dph	bez dph	s dph	bez dph	s dph	
ŽĽAB PODODKVAPOVÝ	B01	bm	125	5,20	6,24	-	-	4,30	5,16	
			150	6,00	7,20	4,50	5,40	5,30	6,36	
ŽĽABOVÝ ROH VNÚTORNÝ 90°	B02	ks	125	12,00	14,40	-	-	7,00	8,40	
			150	14,10	16,92	9,60	11,52	9,60	11,52	
ŽĽABOVÝ ROH VONKAJŠÍ 90°	B03	ks	125	12,00	14,40	-	-	7,00	8,40	
			150	14,10	16,92	9,60	11,52	9,60	11,52	
ŽĽABOVÉ ČELO	B04	ks	125	1,70	2,04	1,50	1,80	3,00	3,60	
			150	1,90	2,28	1,70	2,04	-	-	
ŽĽABOVÝ HÁK S NOSOM L=300 MM	B04	ks	125	2,60	3,12	-	-	3,00	3,60	
			150	2,80	3,36	2,70	3,24	3,20	3,84	
ŽĽABOVÝ HÁK S NOSOM L=350 MM	B06	ks	125	2,70	3,24	-	-	3,00	3,60	
			150	2,90	3,48	2,80	3,36	3,20	3,84	
ŽĽABOVÝ HÁK S PLIEŠKOM L=300 MM	B06N	ks	125	3,20	3,84	-	-	3,40	4,08	
			150	3,60	4,32	3,40	4,08	3,80	4,56	
ŽĽABOVÝ HÁK S PLIEŠKOM L=350 MM	B06N	ks	125	3,50	4,20	-	-	3,70	4,44	
			150	4,10	4,92	4,00	4,80	4,40	5,28	
ŽĽABOVÝ HÁK DO ČELOVEJ DOSKY	B06P	ks	125	2,30	2,76	-	-	2,40	2,88	
			150	2,80	3,36	2,60	3,12	2,90	3,48	
ŽĽABOVÝ HÁK S NOSOM DO ČELOVEJ DOSKY		ks	125	2,20	2,64	-	-	2,30	2,76	
			150	2,70	3,24	2,50	3,00	2,80	3,36	
ŽĽABOVÁ SPOJKA	B11	ks	125	3,60	4,32	-	-	2,30	2,76	
			150	4,80	5,76	-	-	4,00	4,80	
ŽĽABOVÝ KOTLÍK	B12	ks	87	5,40	6,48	-	-	4,60	5,52	
			97	6,40	7,68	6,00	7,20	-	-	
LAPAČ LÍSTIA POZINKOVANÝ	B13	ks	uni	-	-	-	-	4,80	5,76	
ŽĽABOVÝ ÚCHYT UNI	B14	ks	uni	1,30	1,56	-	-	1,10	1,32	
DOČASNÝ ZVOD - FÓLIOVÝ RUKÁV	B20	bm	uni	0,40	0,48	-	-	-	-	
ZVODOVÁ RÚRA L=1000/3000 MM	B21	bm	87	6,20	7,44	-	-	4,70	5,64	
			97	6,60	7,92	5,10	6,12	5,10	6,12	
KOLENO ZVODOVEJ RÚRY 60°	B22	ks	87	5,50	6,60	-	-	4,30	5,16	
			97	6,60	7,92	4,80	5,76	-	-	
REDUKCIA	B24	ks	uni	5,80	6,96	-	-	4,30	5,16	
ZACHYTÁVAČ VODY	B27	ks	87	36,00	43,20	-	-	34,90	41,88	
			97	43,10	51,72	-	-	42,00	50,40	
ZVODOVÁ ODBOČKA	B28	ks	87	29,70	35,64	-	-	24,00	28,80	
			97	33,50	40,20	-	-	28,50	34,20	
OBJÍMKA ZVODOVEJ RÚRY	B26L	ks	87	2,50	3,00	-	-	4,40	5,28	
			97	2,60	3,12	2,10	2,52	4,10	4,92	
HMOŽDINKA DO ZATEPLENEJ FASÁDY IPL		ks	uni	1,30	1,56	-	-	-	-	
NIT TRHACÍ		ks		0,07	0,08	-	-	-	-	
KOMBISKRUTKA S HMOŽDINKOU DO MURIVA M8 X 80								ks	0,29	0,35
KOMBISKRUTKA S HMOŽDINKOU DO MURIVA M8 X 140								ks	0,42	0,50
KOMBISKRUTKA S HMOŽDINKOU DO MURIVA M8 X 200								ks	0,49	0,59
KOMBISKRUTKA S HMOŽDINKOU DO MURIVA M8 X 250								ks	1,24	1,49
KOMBISKRUTKA S HMOŽDINKOU DO MURIVA M8 X 300								ks	1,47	1,76
ÚCHYT OBJÍMKY M8								ks	1,20	1,44
ZÁVITOVÁ TYČKA M8 X 50								ks	0,20	0,24
ZÁVITOVÁ TYČKA M8 X 100								ks	0,30	0,36

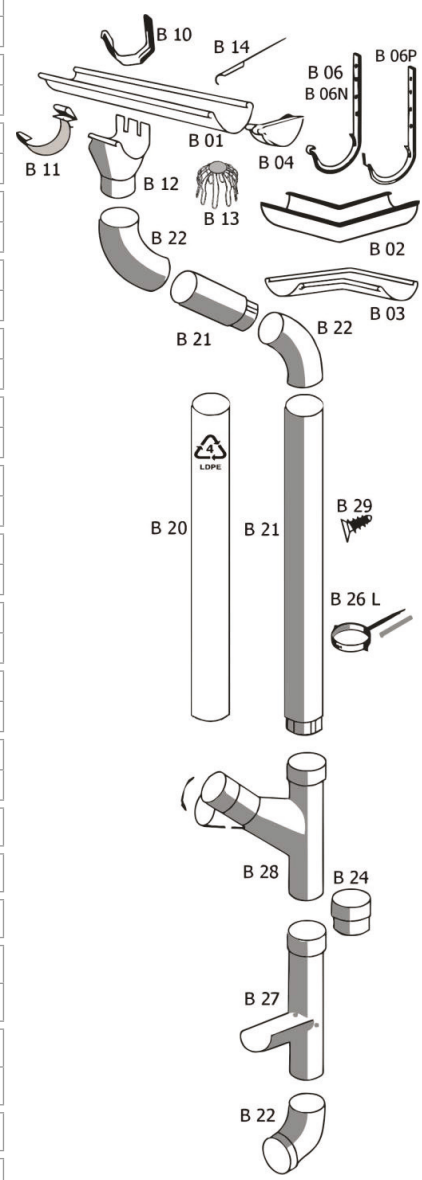

- biela
- tehlová
- červenohnedá
- hnedá
- zelená (len vo veľkosti 150/97)
- šedá
- čierna

*VÝPREDAJ - ALUZINKOVÝ ODKVAPOVÝ SYSTÉM -40%

Neobsahuje všetky komponenty, preto sa dopĺňajú z pozinkovaného odkvapového systému v štandardných cenách.!

Cenník platný od 3.7.2023 • DPH 20% • Slovenský výrobca strešných krytín a trapézových plechov, Badín 655, 976 32 Badín - centrála a výroba



BALENIE A SPRACOVANIE



PALETA POD STREŠNÚ KRYTINU (vratná)	MJ	CENA € / 1 ks bez dph	CENA € / 1ks s dph
2m paleta	ks	30,00	36,00
3m paleta	ks	50,00	60,00
4m paleta	ks	60,00	72,00
5m paleta	ks	70,00	84,00
5m paleta spevnená	ks	90,00	108,00
6m paleta	ks	100,00	120,00
7m paleta predĺžená	ks	140,00	168,00

PALETA POD ŽĽABOVÝ SYSTÉM (vratná)	MJ	CENA € / 1 ks bez dph	CENA € / 1ks s dph
paleta pod žľaby - rúry	ks	80,00	96,00

BALNÉ FALCOVANEJ KRYTINY (vratné do sumy 80%)	MJ	CENA € / 1 ks bez dph	CENA € / 1ks s dph
balné falcovanej krytiny 3m	ks	110,00	132,00
balné falcovanej krytiny 5m	ks	130,00	156,00
balné falcovanej krytiny 7m	ks	150,00	180,00

BALNÉ POD TRAPÉZOVÉ PLECHY (nevratné)	MJ	CENA € / 1 ks bez dph	CENA € / 1ks s dph
podkladové drevo rozmer 75x100x1000mm	ks	1,50	1,80
gumený pás pod drevo (vratné)	ks	6,00	7,20

Odporúčané použitie pri balíkoch trapézov do 2 t	Trapézy T-05, T-30 a STEPRO: vždy na paletu príslušnej dĺžky
dĺžka trapézu: do 3 m - 2 ks od 3 m - do 4 m - 3 ks od 4 m - do 5 m - 4 ks od 5 m - do 6 m - 5 ks od 6 m - do 7 m - 6 ks od 7 m - do 8 m - 7 ks	Trapéz T-12: Od dĺžky 6m - 6m paleta (pri hrúbke do 0,69mm) Od dĺžky 7m - 6m paleta (pri hrúbke od 0,70mm)
	Trapéz T-18, T-35, T-50 a SINUS 40: Od dĺžky 7m - 6m paleta (pri hrúbke do 0,69mm) Od dĺžky 8m - 6m paleta (pri hrúbke od 0,70mm)

OSTATNÉ BALNÉ (vratné)	MJ	CENA € / 1 ks bez dph	CENA € / 1ks s dph
balné pod zvitkový plech	ks	30,00	36,00
balné EUROPALETA	ks	20,00	24,00

BALNÉ RÁMIK NA TRAPÉZOVÉ PLECHY (nevratné)	MJ	CENA € / 1 ks bez dph	CENA € / 1ks s dph
balné do dreveného rámika	ks	6,50	7,80

Špeciálne použitie pri balení trapéz. plechov
dĺžka trapézu: do 4,5 m - 2 ks
do 6,7 m - 3 ks
do 8,9 m - 4 ks
do 11,1 m - 5 ks
do 13,3 m - 6 ks

SPRACOVANIE MATERIÁLU	MJ	CENA € / 1 ks bez dph	CENA € / 1ks s dph
priečne delenie na linke	bm	0,06	0,072
pozdĺžne delenie na linke	bm	0,50	0,60
ochranná fólia lesk	bm	0,50	0,60
ochranná fólia mat	m2	0,60	0,72
ohýbanie materiálu	bm	0,60	0,72
ohýbanie u nás nezakúpeného materiálu	min	0,75	0,90

ZÁLOHY A ZAPOŽIČANIE ZATVÁRAČOV FALCOV

- Záloha za zapožičanie zatvárača falcov Schleich Piccolo: 500 € (600 € s DPH)
- Požičovné za zatvárač falcov Schleich Piccolo: 35 € / deň (42 € s DPH)
- Pri predfalcovaní - prestoj za nepripravenosť staveniska: 15 € / začatú hodinu (18 € s DPH).
- Doprava pri vzdialenosti viac ako 100km od Badína (BB): 0,75 € / km (0,90 € s DPH)
- Pri ploche krytiny menšej ako 100 m² sa fakturuje celá cesta na stavbu a späť: 0,75 € / km (0,90 € s DPH)
- V cene je zahrnutý čas na falcovanie 100 m² za 60 minút. Manipuláciu zvitkov ťažších ako 100 kg zabezpečuje objednávateľ.
- Manipuláciu odoberania predfalcovaných šární (pásov krytiny) zabezpečuje objednávateľ s dostatočným počtom osôb.
- Prívod potrebného elektrického napájania stroja zabezpečuje objednávateľ.
- Predfalcovanie je možné len na prístupnej komunikácii s dostatočným priestorom na manipuláciu a prevádzku stroja.
- Záloha za falcovanie na mieste stavby: Za každých začatých 200m² krytiny - 100€. Vratné iba v prípade splnenia všetkých podmienok.





BANSKÁ BYSTRICA | VÝROBA A CENTRÁLNY SKLAD

Badín 655, 976 32

tel.: +421 48 416 14 97 - 8

| mobil: 0800 800 876

| fax: +421 48 416 24 40

BRATISLAVA

Pri starom letisku 1
831 07 Bratislava
mobil: +421 902 972 080
maslenba@maslen.sk

LUČENEC

Zvolenská 51
984 01 Lučenec
mobil: +421 902 972 040
maslenlc@maslen.sk

POPRAĐ

Levočská 5745
058 01 Poprad
mobil: +421 948 389 864
maslenpp@maslen.sk

TRENČÍN

Zlatovská 24
911 05 Trenčín
mobil: +421 902 972 011
maslentn@maslen.sk

DUNAJSKÁ STREDA

Ádorská 50
929 01 Dunajská Streda
mobil: +421 902 972 060
maslends@maslen.sk

MARTIN

Franc. partizánov 5666
036 01 Martin
mobil: +421 948 908 514
maslenmt@maslen.sk

PREŠOV

Bardejovská 15
080 06 Prešov
mobil: +421 948 972 060
maslenpo@maslen.sk

TRNAVA

Modranská 2
917 01 Trnava
mobil: +421 948 972 020
maslentt@maslen.sk

GALANTA

Priemyselná 3
924 01 Galanta
mobil: +421 948 985 575
maslenga@maslen.sk

MICHALOVCE

Pekárenská 4
071 01 Michalovce
mobil: +421 948 651 115
maslenmi@maslen.sk

PRIEVIDZA

Nadjazdová 1
971 01 Prievidza
mobil: +421 948 920 116
maslenpd@maslen.sk

VEĽKÝ KRTIŠ

Železničná 4
990 01 Veľký Krtíš
mobil: +421 948 612 874
maslenvk@maslen.sk

KRUPINA

ul. Osloboditeľov 920
963 01 Krupina
mobil: +421 948 615 426
maslenka@maslen.sk

NITRA

Novozámocká 64
949 05 Nitra
mobil: +421 902 972 021
maslennr@maslen.sk

SENICA

Železničná 1530
905 01 Senica
mobil: +421 918 180 628
maslense@maslen.sk

ZVOLEN

Neresnícka 2229
962 01 Zvolen
mobil: +421 948 143 188
maslenzv@maslen.sk

KOŠICE

Jarmočná 1896/2
040 01 Košice
mobil: +421 948 389 859
maslenke@maslen.sk

NOVÉ ZÁMKY

Komárňanská cesta 3
940 56 Nové Zámky
mobil: +421 948 389 850
maslennz@maslen.sk

ŠAHY

SNP č. 52
936 01 Šahy
mobil: +421 948 195 385
maslensh@maslen.sk

ŽILINA

Dlhá 87
010 09 Žilina
mobil: +421 948 389 854
maslenza@maslen.sk

LEVICE

Kalnická 9
934 05 Levice
mobil: +421 948 612 874
maslenlv@maslen.sk

PODBREZOVÁ

Štiavnička 674
976 81 Podbrezová
mobil: +421 940 947 102
maslenbr@maslen.sk

ŠTÚROVO

Železničný rad 6
943 02 Štúrovo
mobil: +421 917 729 015
maslenst@maslen.sk

OBCHODNÉ ZASTÚPENIA

ČEČEJOVCE

Košická 2
044 71 Čečejevce
mobil: +421 911 972 022
europlech@europlech.sk

PIEŠŤANY

Rekreačná 7332/4
921 01 Piešťany
mobil: +421 918 919 731
mobil:strechypn@gmail.com

RIMAVSKÁ SOBOTA

Sobôtka 5687
979 01 Rimavská Sobota
mobil: +421 915 802 398
mbsstrechy@mbsstrechy.sk

ŽARNOVICA

Dolná 1491/18
966 81 Žarnovica
mobil: +421 905 501 053
r.r@mail.telekom.sk



INFOLINKA

0800 800 876

www.maslen.sk