



TABUĽKY STATICKÝCH HODNÔT a ÚNOSNOSTI



TRAPÉZOVÉ PLECHY T - 30 STEPRO

Objednávateľ : Ľuboslav DERER, riaditeľ

Vypracoval : prof. Ing. Ján Hudák, CSc.
Ing. Tatiana Hudáková .

Košice, 09 / 2011

STATICKÝ VÝPOČET ÚNOSNOSTI

TRAPÉZOVÝCH PLECHOV

V ZMYSLE EC 3:

T- 30 A, T- 30 B, STEPRO - A, STEPRO - B

OBSAH

PREDSLOV	3
1. PODMIENKY VÝPOČTU STATICKÝCH HODNÔT DIMENZAČNÝCH TABULIEK	4
1.1 ÚVOD	4
1.2 OZNAČENIE PROFILOV	4
1.3 MEDZNÝ STAV ÚNOSNOSTI	4
1.4 MEDZNÝ STAV POUŽÍVATEĽNOSTI	8
1.5 STANOVENIE PRIEREZOVÝCH CHARAKTERISTÍK	10
1.5.1 Súčasný tlak a ohyb steny prierezu	10
1.5.2 Prostý tlak steny prierezu	11
1.5.3 Prostý ohyb steny prierezu	12
1.5.4 Efektívna šírka tlačných stien prierezu	13
1.5.5 Prierezové charakteristiky	14
2. PRIEREZOVÉ CHARAKTERISTIKY TRAPÉZOVÝCH PLECHOV	15
2.1 TRAPÉZ T - 30 A.....	15
2.2 TRAPÉZ T - 30 B	17
2.3 STEPRO - A	19
2.4 STEPRO - B	21
3. MEDZNÉ ZAŤAŽENIA TRAPÉZOVÝCH PLECHOV	23
3.1 TRAPÉZ T - 30 A	23
3.2 TRAPÉZ T - 30 B.....	35
3.3 STEPRO - A	47
3.4 STEPRO - B	59
NORMY, LITERATÚRA	71

PREDSLOV

Predmetom analýzy bolo vypracovanie statických parametrov ohýbaného plechu TRAPEZ T-30 a STEPPO za účelom stanovenia skutočných a efektívnych prierezových charakteristík. Pre tieto charakteristiky boli určené medzné hodnoty rovnomerného zaťaženia prostých a spojitých nosníkov z hľadiska medzného stavu únosnosti a použiteľnosti. Metodika výpočtu bola realizovaná v zmysle EC 3.

Aby sa mohla určiť únosnosť navrhovaných profilov T-30 a STEPPO v rámci tohto zadania boli spracované programy v jazyku TURBO PASCAL:

- Prierezové charakteristiky redukovaného prierezu v normálnej polohe
- Prierezové charakteristiky redukovaného prierezu v reverznej polohe
- Tabuľky únosnosti nosníkov z plechov v normálnej polohe
- Tabuľky únosnosti nosníkov z plechov v reverznej polohe.

Prostredníctvom uvedených programov bolo potrebné spracovať:

- Tabuľky prierezových charakteristík
- Tabuľky medzného zaťaženia trapézových plechov pre vybrané hrúbky. Pre plechy T-30 a STEPPO sú uvažované hrúbky 0,40; 0,50; 0,60; 0,70; 0,75; 0,88; 1,0; 1,25; a 1,50 mm.

Z hodnôt uvedených v tabuľkách boli graficky znázornené únosnosti navrhovaných prierezov pre nosníky o jednom až troch poliach

U profilov T-30 a STEPPO sa uvažuje namáhanie ohybom. Pri tomto ohybe je priebeh napätí po výške prierezu v tvare trojuholníka. Jedná časť pod neutrálnou osou bude ťahaná a druhá časť prierezu na opačnej strane bude tlačaná. A v tejto tlačenej oblasti dochádza k vydúvaniu stienok ak je prekročená ich medná štihlosť. Účinný prierez bol stanovený v zmysle EC 3.

Pre potvrdenie zavedených predpokladov výpočtu bolo by vhodné overiť vypočítané únosnosti pomocou experimentálnych meraní na skutočných nosníkoch.

1. PODMIENKY VÝPOČTU STATICKÝCH HODNÔT DIMENZAČNÝCH TABULIEK

1.1 ÚVOD

Účelom výpočtu bolo vypracovanie tabuliek statických hodnôt prierezových charakteristík a dimenzačných tabuliek hodnôt medzných zaťažení trapezových plechov v zmysle metódy medzných stavov z hľadiska podmienok spoľahlivosti únosnosti a použiteľnosti. Vo výpočte sa uvažovali prierezové charakteristiky efektívnych prierezov, u ktorých sa zohľadnilo vydúvanie najmä tlačenej stien. Pre tieto charakteristiky boli učené medzné hodnoty rovnomerného zaťaženia prostých a spojitého nosníkov z hľadiska medzného stavu **únosnosti** a medzného stavu **použiteľnosti**. Metodika výpočtu bola realizovaná v zmysle ENV 1993-1-1 (Eurokód 3).

1.2 OZNAČENIE PROFILOV

Profily sú označované štandardne TRAPEZ T-30 A, T-30 B, STEPPO-A, STEPPO-B. Poloha trapézových profilov sa môže vyskytnúť ako normálna a reverzná. Normálna poloha je v označení doplnovaná písmenom „A“, reverzná poloha je doplnovaná písmenom „B“.

1.3 MEDZNÝ STAV ÚNOSNOSTI

Pre stanovenie navrhovej hodnoty zaťaženia q z hľadiska podmienky spoľahlivosti medzného stavu únosnosti sa vychádza z teoreticky stanovených ohybových a šmykových únosnosti efektívneho prierezu v charakteristických prierezoch prostého a spojitého nosníka. Vychádza sa z podmienky, že efektívny prierez je plne využitý t.j. že v horných a dolných vláknach je dosiahnutá hodnota medze kizu f_y/γ_{M1} . Predpokladá sa, že efektívny prierez sa po dĺžke nosníka nemení a je stanovený v mieste plného využitia napätia. Zmena veľkosti spolupôsojacej šírky tlačenej steny sa zanedbáva. O únosnosti profilu rozhoduje najviac namáhaný prierez nosníka.

Návrhové hodnoty únosností stanovené z podmienky pevnosti medzného stavu únosnosti sú v tabuľkách označované symbolom *.

a) Nosník o jednom poli

- Momentová únosnosť prierezu

Pre nosník o jednom poli hodnota medzného zaťaženia z hľadiska ohybového momentu bude stanovená z podmienky pevnosti

$$M_{sd} \leq M_{Rd} \quad (1)$$

Hodnoty momentov účinku a únosnosti nosníka budú

$$M_{sd} = 1/8 \cdot q \cdot L^2 \quad (2)$$

$$M_{Rd} = W_{y,eff,min} \cdot f_y / \gamma_{M1} \quad (3)$$

Hodnota medzného zaťaženia z hľadiska ohybového momentu je potom stanovená zo vzťahu

$$q_M = 8 \cdot W_{y,eff,min} \cdot f_y / \gamma_{M1} \cdot 1/L^2 \quad (4)$$

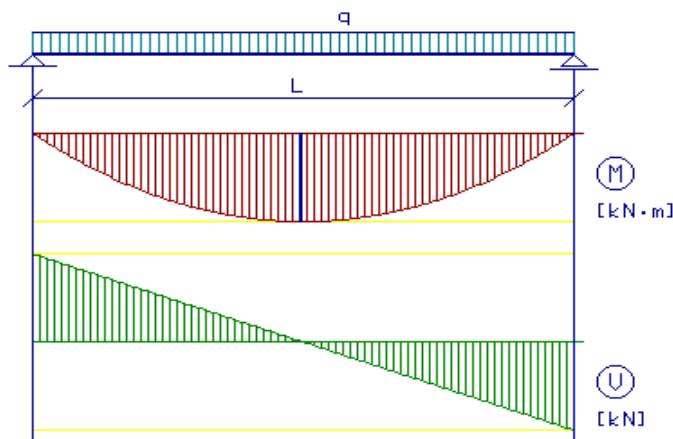

Obr. 1.1: Priebeh ohybových momentov M_{Sd} a priečných síl V_{Sd} jednopoľového nosníka

- Šmyková únosnosť prierezu

U prierezov s viacerými stojinami, vrátane plošných profilov sa lokálna priečna únosnosť nevystužených stíjín určí podľa nasledujúcich vzorcov, ak sú splnené obidve nasledujúce podmienky:

- vzdialenosť „c“ meraná od okraja roznášacej dosky reakcie je min. 40 mm

- priečný rez spĺňa podmienky:

$$r/t \leq 10 \quad (5a)$$

$$h_w/t \leq 200 \cdot \sin \phi \quad (5b)$$

$$45^\circ \leq \phi \leq 90^\circ \quad (5c)$$

kde h_w je výška stojiny medzi strednicami pásnic;

r - vnútorný polomer zaoblenia rohu, Pre existujúci prípad $r = 4$ mm;

ϕ - sklon stojiny vzhľadom k pásnicam (v stupňoch).

Pre prierezy, ktoré splňujú tieto podmienky, sa lokálna priečna únosnosť stojiny jednej stojiny určí zo vzťahu

$$R_{w,Rd} = \alpha \cdot t^2 \cdot \sqrt{f_y} \cdot E \cdot (1 - 0,1 \cdot \sqrt{r/t}) \cdot (0,5 + \sqrt{0,02 \cdot l_a/t}) \cdot (2,4 + (\phi/90)^2) / \gamma_{M1} \quad (6)$$

kde α je súčiniteľ pre príslušnú kategóriu. Pre plošné profily $\alpha = 0,075$;

l_a - efektívna roznášacia dĺžka. Pre existujúci prípad $l_a = 10$ mm.

ϕ - uhol sklonu steny vyšetřovaného profilu. Pre daný prípad $\phi = 71^\circ$.

E - modul pružnosti ocele. Uvažujeme $E = 210000$ MPa.
 U prierezu s vystuženou stojinou, ak splňuje nasledujúcu podmienku

$$2 < e_{\max}/t < 12 \quad (7)$$

kde e_{\max} je väčšia vzdialenosť rohov vystuženej stojiny od spojnice vrcholov dolnej a hornej pásnice.

Pre prierezy s výtuženými stojinami, ktoré splňujú tuto podmienku, možno lokálnu priečnu únosnosť stojiny určiť ako pre nevystuženú stojinu a získanú hodnotu prenásobiť súčiniteľom k_{as} daným vzťahom:

$$k_{as} = 1,45 - 0,05 \cdot e_{\max}/t \quad \text{ale} \quad k_{as} \leq 0,95 + 35000 \cdot t^2 \cdot e_{\min} / (b_d^2 \cdot s_p) \quad (8)$$

kde b_d je šírka zaťaženej pásnice;

e_{\min} je menšia vzdialenosť rohov vystuženej stojiny od spojnice vrcholov dolnej a hornej pásnice.

s_p - šikmá výškarovnej časti stojinypriliehajúcej k zaťaženej pásnici.

Pre nosník o jednom poli hodnota medzného zaťaženia z hľadiska priečnej sily bude stanovená z podmienky pevnosti

$$q_V = n \cdot R_{w,Rd} \cdot 2/L \quad (9)$$

kde n je počet stojín profilu na šírku 1 m (v danom prípade sa uvažovalo s počtom 7 stojín).

Únosnosť prierezu nosníka o jednom poli bude menšia z hodnôt ohybovej a šmykovej únosnosti:

$$q = \min\{q_M, q_V\} \quad (10)$$

b) Nosník o dvoch poliach

Podobne pre nosník o dvoch poliach bude hodnota medzného zaťaženia stanovená zo vzťahu kombinácie ohybového momentu M_{Sd} a lokálneho účinku priečnej sily F_{Sd} . Musia byť splnené tri nasledujúce podmienky:

$$M_{Sd} / M_{c,Rd} \leq 1 \quad (11a)$$

$$F_{Sd} / R_{w,Rd} \leq 1 \quad (11b)$$

$$\frac{M_{Sd}}{M_{c,Rd}} + \frac{F_{Sd}}{R_{w,Rd}} \leq 1,25 \quad (11c)$$

kde $M_{c,Rd}$ je ohybová únosnosť priečného rezu;

$R_{w,Rd}$ - príslušná hodnota lokálnej priečnej únosnosti stojiny.

Po dosadení hodnôt do vzťahu (11c) dostaneme podmienku

$$\frac{0,125 \cdot q \cdot L^2}{W_{eff} \cdot f_y / \gamma_{M1}} + \frac{0,625 \cdot q \cdot L}{n \cdot R_{w,Rd}} \leq 1,25 \quad (12)$$

Po úprave dostávame výsledný vzťah pre únosnosť

$$q = 1,25 / (0,125 \cdot L^2 / (W_{eff} \cdot f_y / \gamma_{M1}) + (0,625 \cdot L / (n \cdot R_{w,Rd}))) \quad (13)$$

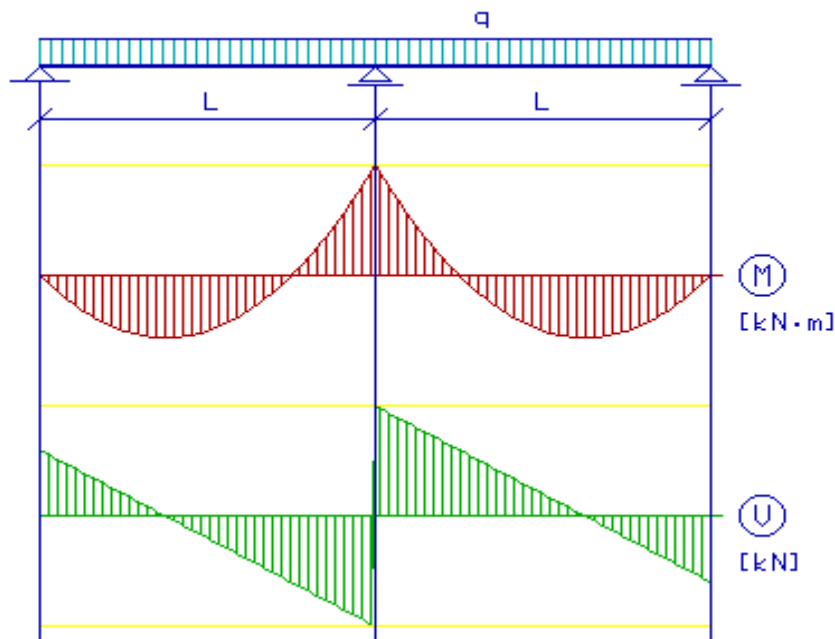

Obr. 1.2: Priebeh ohybových momentov M_{sd} a priečných síl V_{sd} dvojpoľového nosníka

c) Nosník o troch poliach

U nosníka s tromi poľami pre stanovenie únosnosti rozhoduje tiež kombinácia ohybového momentu M_{sd} a priečnej sily F_{sd} . Podobne ako v predchádzajúcom prípade musia byť splnené tri podmienky (11a), (11b) a (11c).

Po dosadení hodnôt do vzťahu (11c) dostaneme podmienku

$$\frac{0,10 \cdot q \cdot L^2}{W_{eff} \cdot f_y / \gamma_{M1}} + \frac{0,617 \cdot q \cdot L}{n \cdot R_{w,Rd}} \leq 1,25 \quad (14)$$

Pre nosník o troch poliach bude hodnota medzného zaťaženia stanovená stanovené zo vzťahu

$$q = 1,25 / (0,10 \cdot L^2 / (W_{eff} \cdot f_y / \gamma_{M1}) + (0,617 \cdot L / (n \cdot R_{w,Rd}))) \quad (15)$$

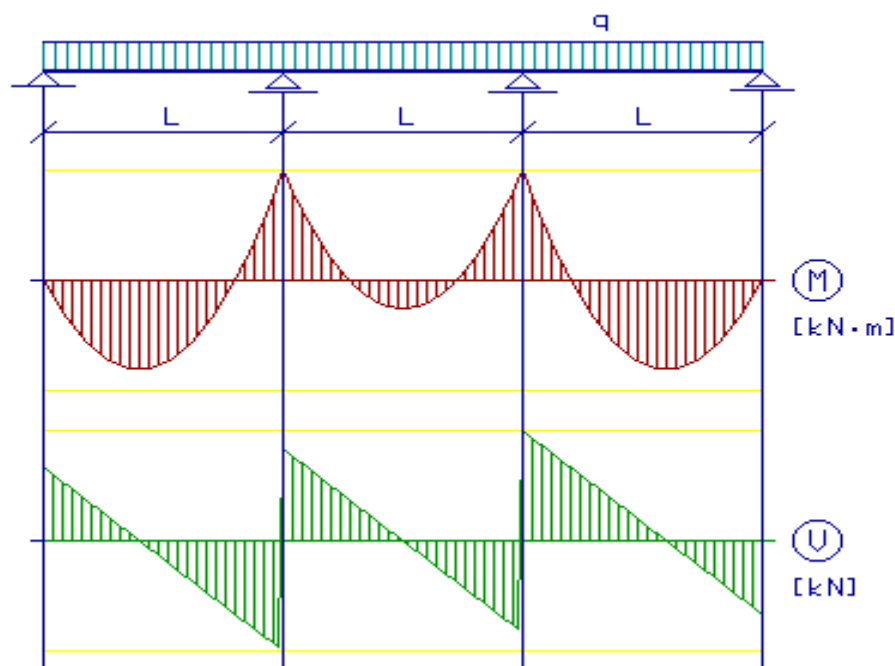

Obr. 1.3: Priebeh ohybových momentov M_{sd} a priečných síl V_{sd} trojpoľového nosníka

1.4 MEDZNÝ STAV POUŽÍVATEĽNOSTI

Pre stanovenie navrhovej hodnoty zaťaženia q z hľadiska podmienky spoľahlivosti medzného stavu použiteľnosti sa vychádzalo z predpokladu pružného pôsobenia profilu a z podmienky maximálneho prípustného priehybu. Predpokladá sa, že efektívny prierez po dosiahnutí medzného priehybu sa po dĺžke nemení. Výsledné medzné charakteristické zaťaženie sa určuje z hodnôt stanovených z obmedzenia vertikálnych priechybov $L/200$, $L/250$ a $L/300$.

a) Nosník o jednom poli

Pre nosník o jednom poli bude hodnota medzného zaťaženia stanovená z podmienky priehybu

$$\delta_{\max} \leq \delta_{\lim} \quad (16)$$

Hodnoty medzného a limitného priehybu nosníka budú

$$\delta_{\max} = \frac{5}{384} \cdot \frac{q/\gamma_F \cdot L^4}{E \cdot I_{y,eff}} \quad (17)$$

$$\delta_{\lim} = \frac{L}{200} \quad (18)$$

Hodnota medzného zaťaženia je potom stanovená zo vzťahu

$$q = 76,8 \cdot \delta_{\text{lim}} \cdot \gamma_F \cdot E \cdot I_{y,\text{eff}} / L^4 \quad (19)$$

kde E je modul pružnosti ocele. (Uvažuje sa z hodnotou 210000 MPa).

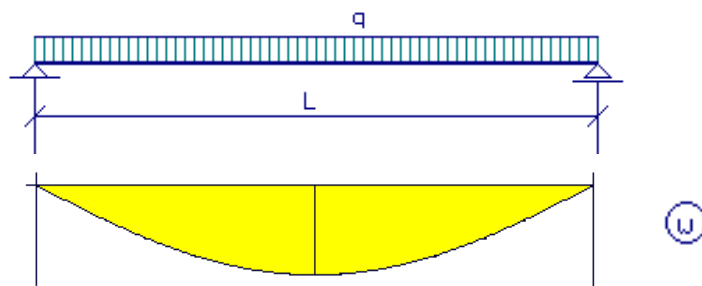

Obr. 1.4: Priehyb jednopol'ového nosníka δ

b) Nosník o dvoch poliach

Podobne pre nosník o dvoch poliach bude hodnota medzného zaťaženia stanovená zo vzťahu

$$q = 185,185 \cdot \delta_{\text{lim}} \cdot \gamma_F \cdot E \cdot I_{y,\text{eff}} / L^4 \quad (20)$$

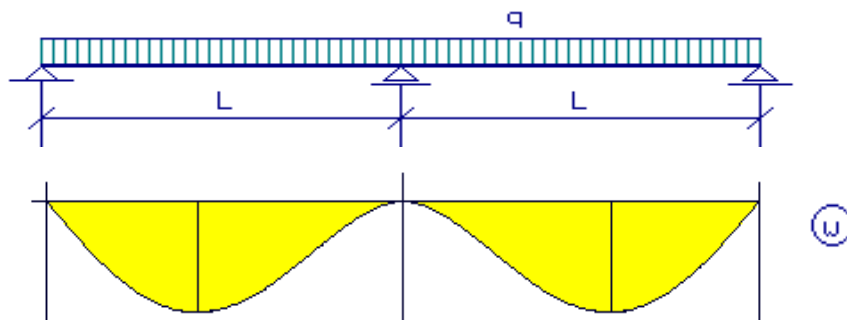

Obr. 1.5: Priehyb dvojpol'ového nosníka δ

c) Nosník o troch poliach

Pre nosník o troch poliach bude hodnota medzného zaťaženia stanovená stanovené zo vzťahu

$$q = 147,059 \cdot \delta_{\text{lim}} \cdot \gamma_F \cdot E \cdot I_{y,\text{eff}} / L^4 \quad (21)$$

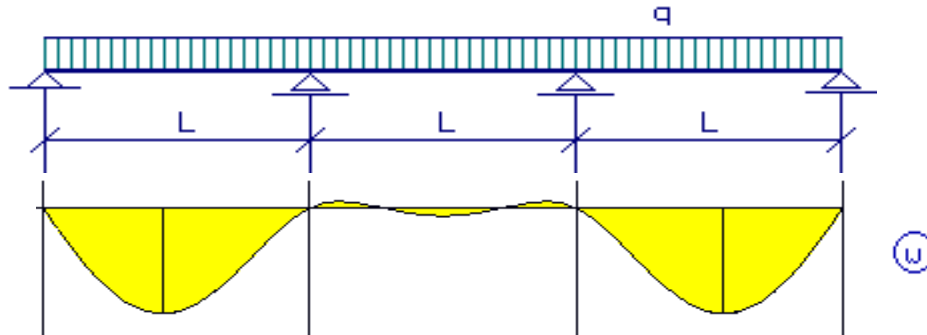

Obr. 1.6: Priehyb trojpoľového nosníka δ

1.5 STANOVENIE PRIEREZOVÝCH CHARAKTERISTÍK

Tenkostenný prierez pozostáva zo súboru tenkých stien. Pri výpočte únosnosti takého prierezu so štíhlymi stenami namáhaného tlakom eventuálne ohybom sa uvažuje s efektívnymi prierezovými charakteristikami. Pre každý taký prierez je potrebné separátne určovať :

- štíhlosť steny β
- medznú štíhlosť steny β_1
- redukovanú štíhlosť steny β_T
- redukčný súčiniteľ ρ
- efektívne šírky stien a pásnic $b_{c,eff}$

V prípade steny obojstranne podpretej je možno uvažovať s namáhaním tlaku a ohybu vyšetrovanej steny tenkostenného prierezu.

1.5.1 Súčasný tlak a ohyb steny prierezu

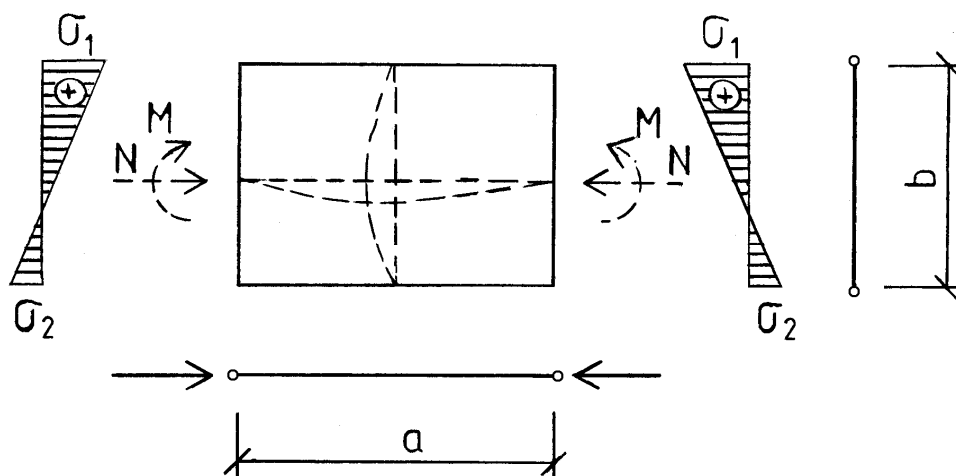

Obr. 1.7: Namáhanie steny kombináciou tlaku a ohybu

Pomer krajných napätí	$\psi = \sigma_2 / \sigma_1$
Štíhlosť steny	$\beta = d / t_w$
Medzná štíhlosť steny	$\beta_{1,NM} = \frac{42 \cdot \sqrt{235 / f_y}}{0,67 + 0,33\psi}$
Redukovaná štíhlosť	$\beta_{T,NM} = 0,8 \cdot \beta + 0,2 \beta_{1,NM}$
Redukčný súčiniteľ	$\rho_{NM} = \frac{\beta_{1,NM}}{\beta_{T,NM}} ; \quad \text{ale} \quad \rho_{NM} \leq 1$

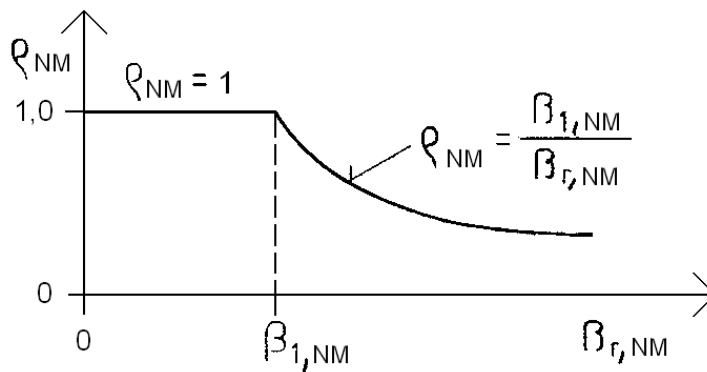

Obr. 1.8: Priebeh redukčného súčiniteľa ρ_{NM}

1.5.2 Prostý tlak steny prierezu

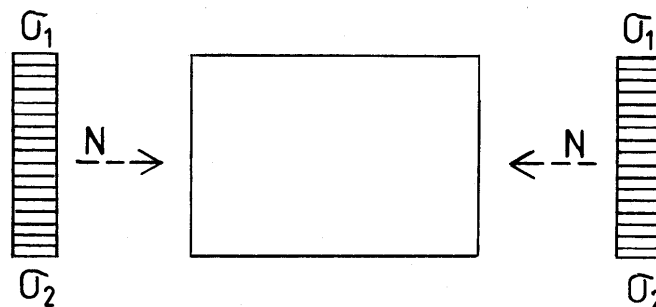

Obr. 1.9: Namáhanie steny tlakom

Pomer krajných napätí:	$\psi = \sigma_2 / \sigma_1$
Medzná štíhlosť steny:	$\beta_{1,N} = \beta_{1,NM} = \frac{40 \sqrt{235 / f_y}}{0,66 + 0,33 \cdot 1} = 40 \cdot \sqrt{235 / f_y}$
Redukovaná štíhlosť steny:	$\beta_{T,N} = 0,8 \cdot \beta + 0,2 \cdot \beta_{1,N}$

Redukčný súčiniteľ: $\rho_N = \frac{\beta_{1,N}}{\beta_{r,N}}$

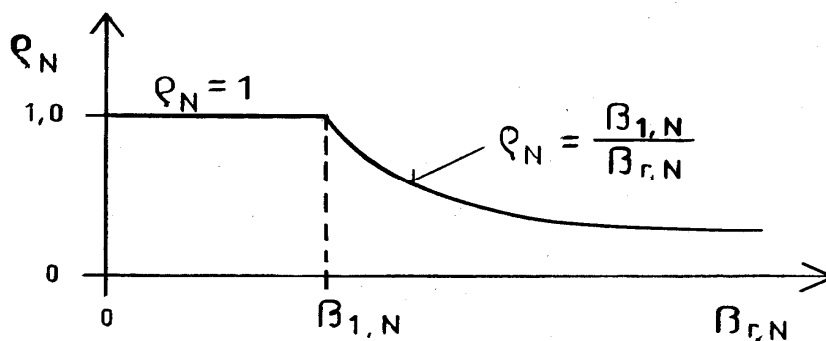

Obr. 1.10: Priebeh redukčného súčiniteľa ρ_N

1.5.3 Prostý ohyb steny prierezu

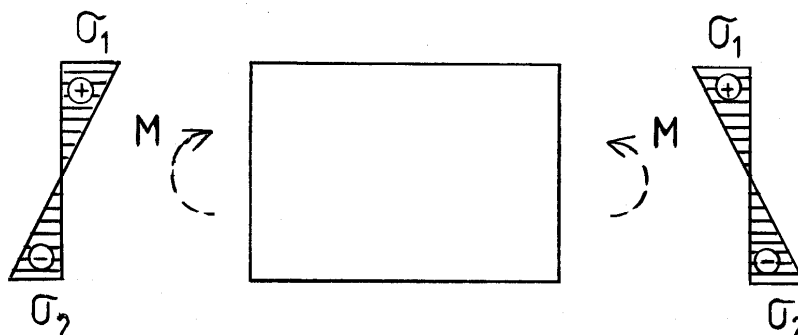

Obr. 1.11: Namáhanie steny ohybom

Pomer krajných napätí: $\psi = \sigma_2 / \sigma_1 = -1$

Medzná štíhlosť steny: $\beta_{1,M} = \beta_{1,NM} = \frac{40 \cdot \sqrt{235 / f_y}}{0,66 + 0,33(-1)} = 130 \sqrt{235 / f_y}$

Redukovaná štíhlosť steny: $\beta_{r,M} = 0,8 \cdot \beta + 0,2 \cdot \beta_{1,M}$

Redukčný súčiniteľ: $\rho_M = \frac{\beta_{1,M}}{\beta_{r,M}}$

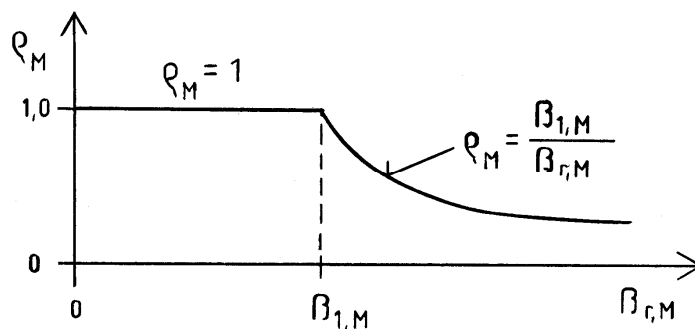

Obr. 1.1.2: Priebeh redukčného súčiniteľa ρ_M

1.5.4 Efektívna šírka tlačných stien prierezu

Efektívna šírka tlačných stien je závislá na priebehu normálových napätí po výške steny

$$b_{c,eff} = b_c \cdot \rho_{NM}$$

$$b_{e1} = 2 \cdot b_{c,eff} / (5 - \psi)$$

$$b_{e2} = b_{c,eff} - b_{e1}$$

$$b_{e1} = 0,4 \cdot b_{c,eff}$$

$$b_{e2} = b_{c,eff} - b_{e1}$$

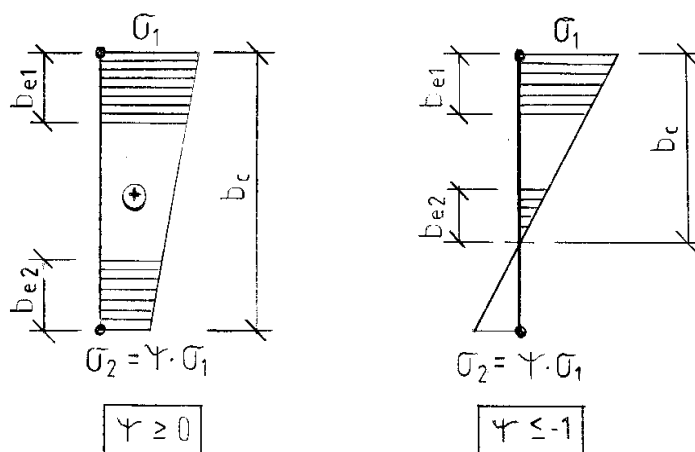

Obr. 1.13: Efektívne šírky prierezu steny pri namáhaní kombináciou tlaku a ohybu

$$b_{c,eff} = b_c \cdot \rho_N$$

$$b_{e1} = b_{e2} = 0,5 \cdot b_{c,eff}$$

$$b_{c,eff} = b_c \cdot \rho_M$$

$$b_{e1} = 0,4 \cdot b_{c,eff}$$

$$b_{e2} = 0,6 \cdot b_{c,eff}$$

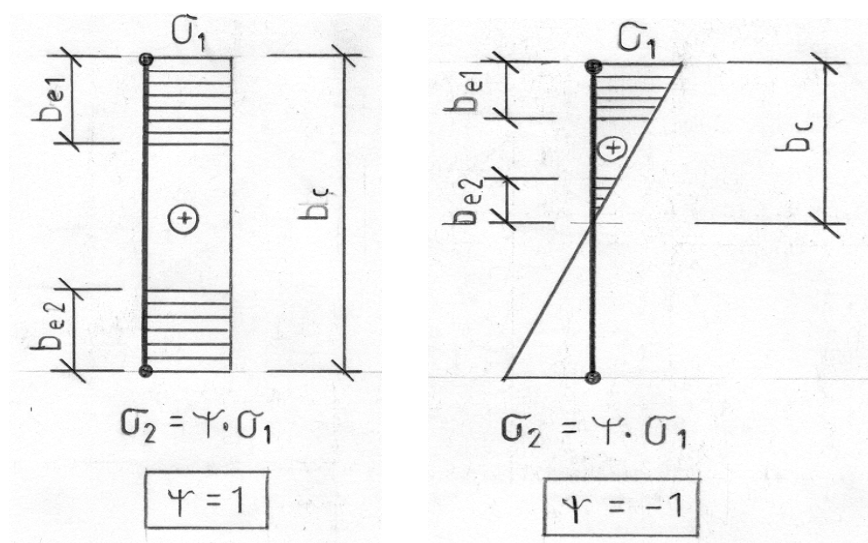

Obr. 1.14: Efektívne šírky prierezu steny pri namáhaní tlakom a ohybom

1.5.5 Prierezové veličiny

Hlavné prierezové veličiny tenkostenného prierezu sú určované z efektívnych rozmerov jednotlivých stien, vytvárajúcich tenkostenný profil.

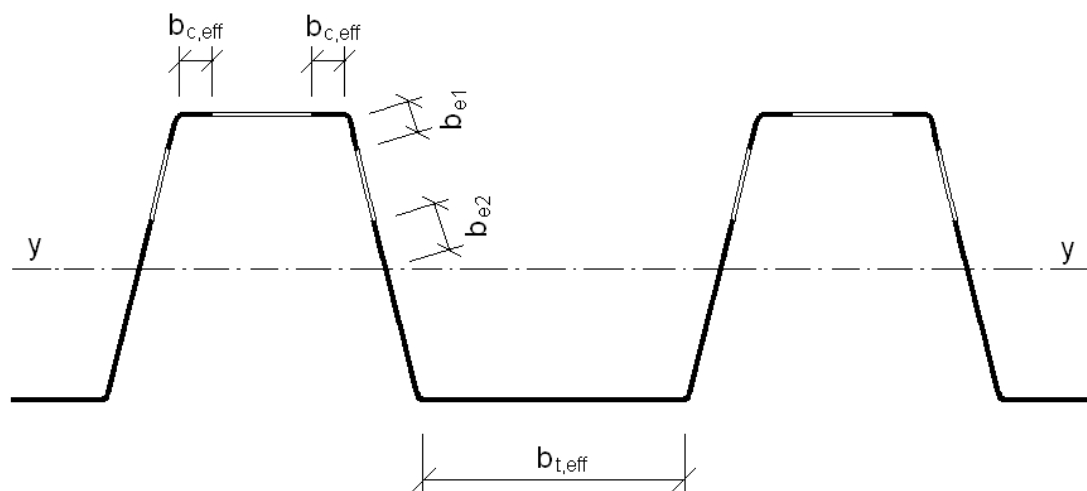

Obr. 1.15: Vyznačenie efektívnych šírok v stenách prierezu

Plocha efektívneho prierezu

$$A_{eff} = \sum A_{i,eff} \quad (22)$$

Ťažisko efektívneho prierezu

$$z_{eff} = \frac{\sum A_{i,eff} \cdot z_i}{A_{eff}} \quad (23)$$

Moment zotrvačnosti efektívneho prierezu

$$I_{y,eff} = \sum (I_{y,i,eff} + A_{i,eff} \cdot z_i^2) \quad (24)$$

Prierezový modul efektívneho prierezu

$$W_{y,eff} = \frac{I_{y,eff}}{z_{eff}} \quad (25)$$

POZNÁMKA:

Trapezové plechy sú uložené na podperných podsystemoch. Šírky podpier ovplyvňujú hodnoty ohybového momentu. Odporúčaná minimálna šírka vnútorných podpier pre spojitý nosníky je 60 mm.

2. PRIEREZOVÉ CHARAKTERISTIKY TRAPÉZOVÝCH PLECHOV

2.1 TRAPÉZ T - 30 A - efektívny prierez

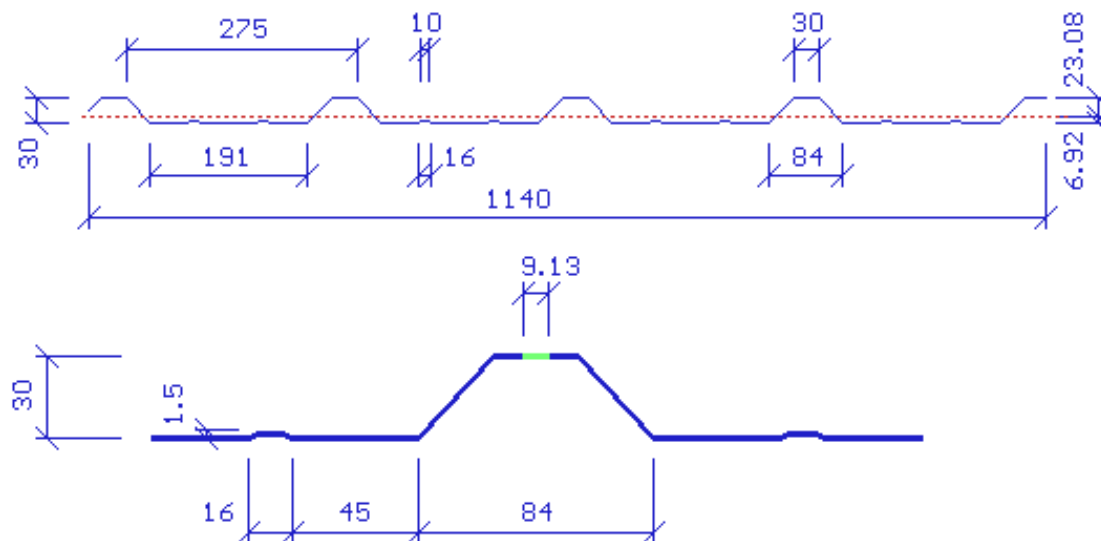

Obr. 2.1: Tvar prierezu T - 30 A

PRIEREZOVÉ CHARAKTERISTIKY T - 30 A

Oceľ S 220 GD

t [mm]	b_h [mm]	A_{eff} [mm ² /m]	e_h [mm]	e_d [mm]	$I_{y,eff}$ [mm ⁴ /m]	$W_{y,h}$ [mm ³ /m]	$W_{y,d}$ [mm ³ /m]
0,40	30	415,272	23,345	6,655	0,0428	1,834	6,436
0,50	30	526,478	22,984	7,016	0,0571	2,483	8,135
0,60	30	640,149	22,651	7,349	0,0723	3,192	9,839
0,70	30	756,085	22,344	7,656	0,0884	3,954	11,540
0,75	30	812,742	22,255	7,745	0,0956	4,299	12,353
0,88	30	954,803	22,184	7,816	0,1121	5,052	14,340
1,00	30	1086,193	22,120	7,880	0,1271	5,747	16,132
1,25	30	1360,646	21,991	8,009	0,1581	7,189	19,740
1,50	30	1635,969	21,867	8,133	0,1885	8,621	23,178
Násob.	-	-	-	-	10 ⁶	10 ³	10 ³

PRIEREZOVÉ CHARAKTERISTIKY T - 30 A

Oceľ S 250 GD

t [mm]	b_h [mm]	A_{eff} [mm ² /m]	e_h [mm]	e_d [mm]	$I_{y,eff}$ [mm ⁴ /m]	$W_{y,h}$ [mm ³ /m]	$W_{y,d}$ [mm ³ /m]
0,40	30	413,724	23,432	6,568	0,0420	1,793	6,396
0,50	30	524,190	23,083	6,917	0,0559	2,422	8,083
0,60	30	637,025	22,761	7,239	0,0707	3,109	9,775
0,70	30	752,048	22,462	7,538	0,0864	3,848	11,466
0,75	30	810,328	22,320	7,680	0,0945	4,235	12,309
0,88	30	954,167	22,199	7,801	0,1117	5,035	14,326
1,00	30	1085,398	22,136	7,864	0,1267	5,726	16,116
1,25	30	1359,480	22,009	7,991	0,1576	7,159	19,719
1,50	30	1634,392	21,887	8,113	0,1878	8,582	23,153
Násob.	-	-	-	-	10 ⁶	10 ³	10 ³

PRIEREZOVÉ CHARAKTERISTIKY T - 30 A

Oceľ S 280 GD

t [mm]	b_h [mm]	A_{eff} [mm ² /m]	e_h [mm]	e_d [mm]	$I_{y,eff}$ [mm ⁴ /m]	$W_{y,h}$ [mm ³ /m]	$W_{y,d}$ [mm ³ /m]
0,40	30	412,415	23,506	6,494	0,0413	1,758	6,362
0,50	30	522,248	23,168	6,832	0,0549	2,370	8,038
0,60	30	634,368	22,855	7,145	0,0694	3,038	9,719
0,70	30	748,606	22,564	7,436	0,0848	3,757	11,399
0,75	30	806,472	22,425	7,575	0,0927	4,133	12,237
0,88	30	953,629	22,211	7,789	0,1115	5,019	14,314
1,00	30	1084,723	22,149	7,851	0,1264	5,707	16,102
1,25	30	1358,489	22,025	7,975	0,1571	7,134	19,701
1,50	30	1633,046	21,904	8,096	0,1872	8,549	23,131
Násob.	-	-	-	-	10 ⁶	10 ³	10 ³

PRIEREZOVÉ CHARAKTERISTIKY T - 30 A

Oceľ S 320 GD

t [mm]	b_h [mm]	A_{eff} [mm ² /m]	e_h [mm]	e_d [mm]	$I_{y,eff}$ [mm ⁴ /m]	$W_{y,h}$ [mm ³ /m]	$W_{y,d}$ [mm ³ /m]
0,40	30	410,947	23,589	6,411	0,0405	1,718	6,322
0,50	30	520,065	23,264	6,736	0,0538	2,312	7,985
0,60	30	631,371	22,962	7,038	0,0679	2,959	9,654
0,70	30	744,715	22,680	7,320	0,0829	3,654	11,321
0,75	30	802,107	22,545	7,455	0,0906	4,018	12,153
0,88	30	953,025	22,225	7,775	0,1112	5,003	14,300
1,00	30	1083,965	22,165	7,835	0,1260	5,686	16,085
1,25	30	1357,371	22,042	7,958	0,1566	7,104	19,679
1,50	30	1631,524	21,924	8,076	0,1866	8,510	23,104
Násob.	-	-	-	-	10 ⁶	10 ³	10 ³

2.2 TRAPÉZ T - 30 B - efektívny prierez

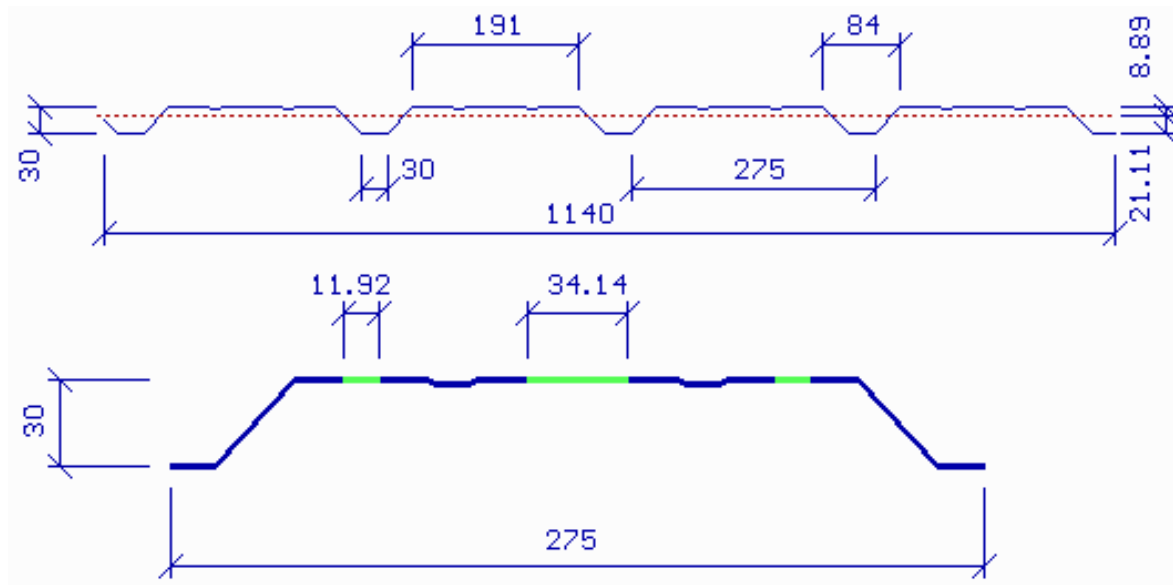

Obr. 2.2: Tvar prierezu T - 30 B

PRIEREZOVÉ CHARAKTERISTIKY T - 30 B

Oceľ S 220 GD

t [mm]	b_h [mm]	A_{eff} [mm ² /m]	e_h [mm]	e_d [mm]	$I_{y,eff}$ [mm ⁴ /m]	$W_{y,h}$ [mm ³ /m]	$W_{y,d}$ [mm ³ /m]
0,40	191	290,607	10,687	19,313	0,0399	3,735	2,067
0,50	191	387,006	10,061	19,939	0,0520	5,170	2,609
0,60	191	491,933	9,532	20,468	0,0645	6,768	3,152
0,70	191	604,882	9,080	20,920	0,0773	8,509	3,693
0,75	191	664,242	8,879	21,121	0,0837	9,429	3,969
0,88	191	827,154	8,418	21,582	0,1006	11,955	4,663
1,00	191	987,986	8,060	21,940	0,1164	14,439	5,304
1,25	191	1305,577	7,716	22,284	0,1469	19,038	6,592
1,50	191	1615,792	7,568	22,432	0,1758	23,233	7,838
Násob.	-	-	-	-	10 ⁶	10 ³	10 ³

PRIEREZOVÉ CHARAKTERISTIKY T – 30 B

Oceľ S 250 GD

t [mm]	b_h [mm]	A_{eff} [mm ² /m]	e_h [mm]	e_d [mm]	$I_{y,eff}$ [mm ⁴ /m]	$W_{y,h}$ [mm ³ /m]	$W_{y,d}$ [mm ³ /m]
0,40	191	285,205	10,863	19,137	0,0394	3,625	2,058
0,50	191	379,787	10,248	19,752	0,0513	5,007	2,598
0,60	191	481,869	9,725	20,275	0,0636	6,543	3,138
0,70	191	591,649	9,276	20,724	0,0762	8,219	3,678
0,75	191	649,307	9,074	20,926	0,0826	9,104	3,948
0,88	191	807,469	8,613	21,387	0,0993	11,536	4,646
1,00	191	963,546	8,252	21,748	0,1149	13,929	5,285
1,25	191	1292,553	7,788	22,212	0,1462	18,778	6,584
1,50	191	1598,138	7,643	22,357	0,1749	22,895	7,827
Násob.	-	-	-	-	10 ⁶	10 ³	10 ³

PRIEREZOVÉ CHARAKTERISTIKY T – 30 B

Oceľ S 280 GD

t [mm]	b_h [mm]	A_{eff} [mm ² /m]	e_h [mm]	e_d [mm]	$I_{y,eff}$ [mm ⁴ /m]	$W_{y,h}$ [mm ³ /m]	$W_{y,d}$ [mm ³ /m]
0,40	191	281,762	11,016	18,984	0,0389	3,533	2,050
0,50	191	373,682	10,411	19,589	0,0507	4,869	2,588
0,60	191	473,366	9,894	20,106	0,0628	6,354	3,127
0,70	191	580,448	9,448	20,552	0,0753	7,973	3,665
0,75	191	636,655	9,247	20,753	0,0816	8,828	3,934
0,88	191	790,755	8,785	21,215	0,0982	11,179	4,629
1,00	191	942,754	8,423	21,577	0,1137	13,495	5,268
1,25	191	1281,484	7,850	22,150	0,1457	18,557	6,576
1,50	191	1583,089	7,709	22,291	0,1743	22,606	7,817
Násob.	-	-	-	-	10 ⁶	10 ³	10 ³

PRIEREZOVÉ CHARAKTERISTIKY T - 30 B

Oceľ S 320 GD

t [mm]	b_h [mm]	A_{eff} [mm ² /m]	e_h [mm]	e_d [mm]	$I_{y,eff}$ [mm ⁴ /m]	$W_{y,h}$ [mm ³ /m]	$W_{y,d}$ [mm ³ /m]
0,40	191	277,248	11,192	18,808	0,0384	3,429	2,041
0,50	191	366,850	10,600	19,400	0,0499	4,714	2,576
0,60	191	463,834	10,091	19,909	0,0619	6,141	3,112
0,70	191	567,869	9,649	20,351	0,0742	7,696	3,649
0,75	191	622,434	9,450	20,550	0,0805	8,517	3,917
0,88	191	771,930	8,989	21,011	0,0968	10,776	4,610
1,00	191	919,291	8,625	21,375	0,1121	13,003	5,247
1,25	191	1253,204	8,013	21,987	0,1441	17,991	6,556
1,50	191	1566,075	7,784	22,216	0,1734	22,279	7,817
Násob.	-	-	-	-	10 ⁶	10 ³	10 ³

2.3 STEPPO - A - efektívny prierez

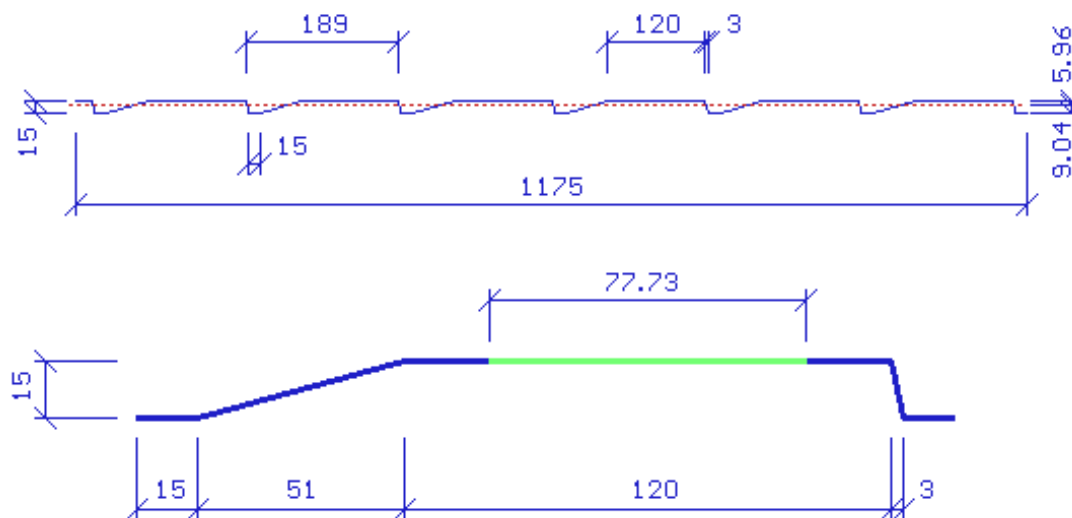

Obr. 2.3: Tvar prierezu STEPPO - A

PRIEREZOVÉ CHARAKTERISTIKY STEPPO - A

Oceľ S 220 GD

t [mm]	b_h [mm]	A_{eff} [mm ² / m]	e_h [mm]	e_d [mm]	$I_{y,eff}$ [mm ⁴ / m]	$W_{y,h}$ [mm ³ / m]	$W_{y,d}$ [mm ³ / m]
0,40	120	218,725	7,143	7,857	0,0065	0,912	0,829
0,50	120	286,017	6,839	8,161	0,0086	1,260	1,056
0,60	120	358,105	6,569	8,431	0,0108	1,648	1,284
0,70	120	434,870	6,329	8,671	0,0131	2,071	1,511
0,75	120	474,971	6,218	8,782	0,0142	2,295	1,425
0,88	120	584,475	5,958	9,042	0,0173	2,910	1,917
1,00	120	692,114	5,747	9,253	0,0202	3,515	2,183
1,25	120	935,793	5,385	9,615	0,0262	4,864	2,724
1,50	120	1204,483	5,103	9,897	0,0321	6,289	3,242
Násob.	-	-	-	-	10 ⁶	10 ³	10 ³

PRIEREZOVÉ CHARAKTERISTIKY STEPPO - A

Oceľ S 250 GD

t [mm]	b_h [mm]	A_{eff} [mm ² /m]	e_h [mm]	e_d [mm]	$I_{y,eff}$ [mm ⁴ /m]	$W_{y,h}$ [mm ³ /m]	$W_{y,d}$ [mm ³ /m]
0,40	120	216,189	7,225	7,775	0,0064	0,885	0,822
0,50	120	282,117	6,930	8,070	0,0084	1,219	1,047
0,60	120	352,577	6,667	8,333	0,0106	1,590	1,272
0,70	120	427,465	6,432	8,568	0,0128	1,996	1,498
0,75	120	466,537	6,324	8,676	0,0139	2,210	1,611
0,88	120	573,097	6,067	8,933	0,0169	2,799	1,901
1,00	120	677,692	5,859	9,141	0,0198	3,379	2,166
1,25	120	914,103	5,498	9,502	0,0257	4,672	2,703
1,50	120	1174,396	5,214	9,786	0,0315	6,041	3,219
Násob.	-	-	-	-	10 ⁶	10 ³	10 ³

PRIEREZOVÉ CHARAKTERISTIKY STEPPO - A

Oceľ S 280 GD

t [mm]	b_h [mm]	A_{eff} [mm ² /m]	e_h [mm]	e_d [mm]	$I_{y,eff}$ [mm ⁴ /m]	$W_{y,h}$ [mm ³ /m]	$W_{y,d}$ [mm ³ /m]
0,40	120	214,064	7,294	7,706	0,0063	0,862	0,816
0,50	120	278,847	7,008	7,992	0,0083	1,184	1,038
0,60	120	347,938	6,752	8,248	0,0104	1,542	1,262
0,70	120	421,224	6,522	8,478	0,0126	1,932	1,487
0,75	120	459,449	6,416	8,584	0,0137	2,139	1,598
0,88	120	563,525	6,163	8,837	0,0167	2,706	1,887
1,00	120	665,546	5,957	9,043	0,0194	3,263	2,150
1,25	120	895,797	5,597	9,403	0,0252	4,509	2,684
1,50	120	1148,954	5,313	9,687	0,0309	5,830	3,198
Násob.	-	-	-	-	10 ⁶	10 ³	10 ³

PRIEREZOVÉ CHARAKTERISTIKY STEPPO - A

Oceľ S 320 GD

t [mm]	b_h [mm]	A_{eff} [mm ² /m]	e_h [mm]	e_d [mm]	$I_{y,eff}$ [mm ⁴ /m]	$W_{y,h}$ [mm ³ /m]	$W_{y,d}$ [mm ³ /m]
0,40	120	211,701	7,374	7,626	0,0061	0,836	0,808
0,50	120	275,207	7,098	7,902	0,0081	1,145	1,029
0,60	120	342,772	6,850	8,150	0,0102	1,488	1,251
0,70	120	414,310	6,625	8,375	0,0123	1,862	1,473
0,75	120	451,544	6,521	8,479	0,0134	2,059	1,584
0,88	120	552,838	6,274	8,726	0,0163	2,601	1,870
1,00	120	651,972	6,071	8,929	0,0190	3,134	2,131
1,25	120	875,300	5,714	9,286	0,0247	4,326	2,662
1,50	120	1120,411	5,429	9,571	0,0303	5,592	3,172
Násob.	-	-	-	-	10 ⁶	10 ³	10 ³

2.4 STEPPO - B - efektívny prierez

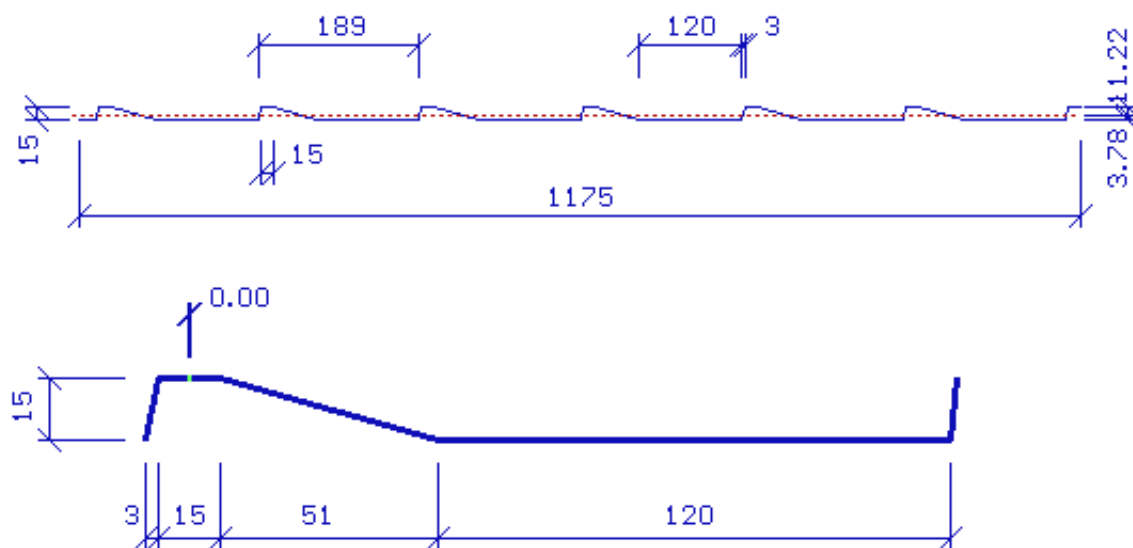

Obr. 2.4: Tvar prierezu STEPPO - B

PRIEREZOVÉ CHARAKTERISTIKY STEPPO - B

Oceľ S 220 GD

t [mm]	b_h [mm]	A_{eff} [mm ² /m]	e_h [mm]	e_d [mm]	$I_{y,eff}$ [mm ⁴ /m]	$W_{y,h}$ [mm ³ /m]	$W_{y,d}$ [mm ³ /m]
0,40	15	430,444	11,269	3,731	0,0117	1,040	3,140
0,50	15	538,008	11,243	3,757	0,0144	1,286	3,849
0,60	15	645,553	11,218	3,782	0,0171	1,527	4,529
0,70	15	753,080	11,192	3,808	0,0197	1,762	5,180
0,75	15	806,836	11,179	3,821	0,0210	1,878	5,496
0,88	15	946,581	11,146	3,854	0,0242	2,173	6,287
1,00	15	1075,548	11,115	3,885	0,0271	2,438	6,978
1,25	15	1344,143	11,052	3,948	0,0328	2,968	8,307
1,50	15	1612,621	10,988	4,012	0,0381	3,468	9,496
Násob.	-	-	-	-	10 ⁶	10 ³	10 ³

PRIEREZOVÉ CHARAKTERISTIKY STEPPO - B

Oceľ S 250 GD

t [mm]	b_h [mm]	A_{eff} [mm ² /m]	e_h [mm]	e_d [mm]	$I_{y,eff}$ [mm ⁴ /m]	$W_{y,h}$ [mm ³ /m]	$W_{y,d}$ [mm ³ /m]
0,40	15	430,444	11,269	3,731	0,0117	1,040	3,140
0,50	15	538,008	11,243	3,757	0,0144	1,286	3,849
0,60	15	645,553	11,218	3,782	0,0171	1,527	4,529
0,70	15	753,080	11,192	3,808	0,0197	1,762	5,180
0,75	15	806,836	11,179	3,821	0,0210	1,878	5,496
0,88	15	946,581	11,146	3,854	0,0242	2,173	6,287
1,00	15	1075,548	11,115	3,885	0,0271	2,438	6,978
1,25	15	1344,143	11,052	3,948	0,0328	2,968	8,307
1,50	15	1612,621	10,988	4,012	0,0381	3,468	9,496
Násob.	-	-	-	-	10 ⁶	10 ³	10 ³

PRIEREZOVÉ CHARAKTERISTIKY STEPPO - B

Oceľ S 280 GD

t [mm]	b_h [mm]	A_{eff} [mm ² /m]	e_h [mm]	e_d [mm]	$I_{y,eff}$ [mm ⁴ /m]	$W_{y,h}$ [mm ³ /m]	$W_{y,d}$ [mm ³ /m]
0,40	15	430,444	11,269	3,731	0,0117	1,040	3,140
0,50	15	538,008	11,243	3,757	0,0144	1,286	3,849
0,60	15	645,553	11,218	3,782	0,0171	1,527	4,529
0,70	15	753,080	11,192	3,808	0,0197	1,762	5,180
0,75	15	806,836	11,179	3,821	0,0210	1,878	5,496
0,88	15	946,581	11,146	3,854	0,0242	2,173	6,287
1,00	15	1075,548	11,115	3,885	0,0271	2,438	6,978
1,25	15	1344,143	11,052	3,948	0,0328	2,968	8,307
1,50	15	1612,621	10,988	4,012	0,0381	3,468	9,496
Násob.	-	-	-	-	10 ⁶	10 ³	10 ³

PRIEREZOVÉ CHARAKTERISTIKY STEPPO - B

Oceľ S 320 GD

t [mm]	b_h [mm]	A_{eff} [mm ² /m]	e_h [mm]	e_d [mm]	$I_{y,eff}$ [mm ⁴ /m]	$W_{y,h}$ [mm ³ /m]	$W_{y,d}$ [mm ³ /m]
0,40	15	430,444	11,269	3,731	0,0117	1,040	3,140
0,50	15	538,008	11,243	3,757	0,0144	1,286	3,849
0,60	15	645,553	11,218	3,782	0,0171	1,527	4,529
0,70	15	753,080	11,192	3,808	0,0197	1,762	5,180
0,75	15	806,836	11,179	3,821	0,0210	1,878	5,496
0,88	15	946,581	11,146	3,854	0,0242	2,173	6,287
1,00	15	1075,548	11,115	3,885	0,0271	2,438	6,978
1,25	15	1344,143	11,052	3,948	0,0328	2,968	8,307
1,50	15	1612,621	10,988	4,012	0,0381	3,468	9,496
Násob.	-	-	-	-	10 ⁶	10 ³	10 ³

3. MEDZNÉ ZAŤAŽENIA PLECHOV

3.1 TRAPÉZ T- 30 A,eff

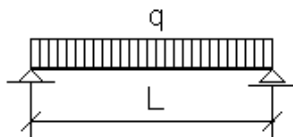

TRAPEZ T - 30 A,eff

Oceľ S 220 GD

t	g	Kritérium pre	Medzné zaťaženie q [kN/m^2] pre rozpätie L [m]									
			1,00	1,25	1,50	1,75	2,00	2,25	2,50	2,75	3,00	
[mm]	[kg/m^2]	* pevnosť δ_{max}										
0,40	3,44	*	2.45	1.79	1.24	0.91	0.70	0.55	0.45	0.37	0.31	
		L/200	2.45	1.71	0.99	0.62	0.42	0.29	0.21	0.16	0.12	
		L/250	2.45	1.37	0.79	0.50	0.33	0.23	0.17	0.13	0.10	
		L/300	2.23	1.14	0.66	0.42	0.28	0.20	0.14	0.11	0.08	
0,50	4,30	*	3.78	2.42	1.68	1.23	0.95	0.75	0.61	0.50	0.42	
		L/200	3.78	2.29	1.32	0.83	0.56	0.39	0.29	0.21	0.17	
		L/250	3.57	1.83	1.06	0.67	0.45	0.31	0.23	0.17	0.13	
		L/300	2.98	1.52	0.88	0.56	0.37	0.26	0.19	0.14	0.11	
0,60	5,16	*	4.86	3.11	2.16	1.59	1.22	0.96	0.78	0.64	0.54	
		L/200	4.86	2.90	1.68	1.06	0.71	0.50	0.36	0.27	0.21	
		L/250	4.53	2.32	1.34	0.84	0.57	0.40	0.29	0.22	0.17	
		L/300	3.77	1.93	1.12	0.70	0.47	0.33	0.24	0.18	0.14	
0,70	6,02	*	6.02	3.85	2.68	1.97	1.51	1.19	0.96	0.80	0.67	
		L/200	6.02	3.54	2.05	1.29	0.87	0.61	0.44	0.33	0.26	
		L/250	5.54	2.84	1.64	1.03	0.69	0.49	0.35	0.27	0.21	
		L/300	4.62	2.36	1.37	0.86	0.58	0.41	0.30	0.22	0.17	
0,75	6,46	*	6.53	4.18	2.90	2.13	1.63	1.29	1.05	0.86	0.73	
		L/200	6.53	3.83	2.22	1.40	0.94	0.66	0.48	0.36	0.28	
		L/250	5.99	3.07	1.77	1.12	0.75	0.53	0.38	0.29	0.22	
		L/300	4.99	2.56	1.48	0.93	0.62	0.44	0.32	0.24	0.18	
0,88	7,57	*	7.61	4.87	3.38	2.49	1.90	1.50	1.22	1.01	0.85	
		L/200	7.61	4.46	2.58	1.63	1.09	0.76	0.56	0.42	0.32	
		L/250	6.97	3.57	2.06	1.30	0.87	0.61	0.45	0.34	0.26	
		L/300	5.81	2.97	1.72	1.08	0.73	0.51	0.37	0.28	0.22	
1,00	8,61	*	8.60	5.50	3.82	2.81	2.15	1.70	1.38	1.14	0.96	
		L/200	8.60	5.03	2.91	1.83	1.23	0.86	0.63	0.47	0.36	
		L/250	7.86	4.02	2.33	1.47	0.98	0.69	0.50	0.38	0.29	
		L/300	6.55	3.35	1.94	1.22	0.82	0.57	0.42	0.31	0.24	
1,25	10,76	*	10.61	6.79	4.71	3.46	2.65	2.10	1.70	1.40	1.18	
		L/200	10.61	6.18	3.58	2.25	1.51	1.06	0.77	0.58	0.45	
		L/250	9.66	4.95	2.86	1.80	1.21	0.85	0.62	0.46	0.36	
		L/300	8.05	4.12	2.39	1.50	1.01	0.71	0.52	0.39	0.30	
1,50	12,91	*	12.56	8.04	5.58	4.10	3.14	2.48	2.01	1.66	1.40	
		L/200	12.56	7.30	4.22	2.66	1.78	1.25	0.91	0.69	0.53	
		L/250	11.40	5.84	3.38	2.13	1.43	1.00	0.73	0.55	0.42	
		L/300	9.50	4.87	2.82	1.77	1.19	0.83	0.61	0.46	0.35	

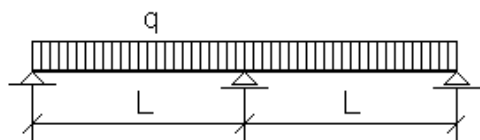

TRAPEZ T - 30 A,eff

Oceľ S 220 GD

<i>t</i>	<i>g</i>	Kritérium pre	Medzné zaťaženie <i>q</i> [kN/m ²] pre rozpätie <i>L</i> [m]									
			1,00	1,25	1,50	1,75	2,00	2,25	2,50	2,75	3,00	
[mm]	[kg/m ²]	* pevnosť δ_{max}										
0,40	3,44	*	2.17	1.62	1.26	1.02	0.84	0.71	0.61	0.52	0.46	
		L/200	2.17	1.62	1.26	1.02	0.84	0.71	0.52	0.39	0.30	
		L/250	2.17	1.62	1.26	1.02	0.81	0.57	0.41	0.31	0.24	
		L/300	2.17	1.62	1.26	1.00	0.67	0.47	0.34	0.26	0.20	
0,50	4,30	*	3.33	2.46	1.91	1.53	1.26	1.05	0.90	0.77	0.67	
		L/200	3.33	2.46	1.91	1.53	1.26	0.94	0.69	0.52	0.40	
		L/250	3.33	2.46	1.91	1.53	1.08	0.76	0.55	0.41	0.32	
		L/300	3.33	2.46	1.91	1.34	0.90	0.63	0.46	0.35	0.27	
0,60	5,16	*	4.67	3.44	2.66	2.12	1.74	1.45	1.23	1.06	0.92	
		L/200	4.67	3.44	2.66	2.12	1.71	1.20	0.87	0.66	0.51	
		L/250	4.67	3.44	2.66	2.04	1.36	0.96	0.70	0.53	0.40	
		L/300	4.67	3.44	2.66	1.70	1.14	0.80	0.58	0.44	0.34	
0,70	6,02	*	6.20	4.55	3.50	2.78	2.27	1.89	1.60	1.38	1.20	
		L/200	6.20	4.55	3.50	2.78	2.09	1.47	1.07	0.80	0.62	
		L/250	6.20	4.55	3.50	2.49	1.67	1.17	0.85	0.64	0.49	
		L/300	6.20	4.55	3.30	2.08	1.39	0.98	0.71	0.54	0.41	
0,75	6,46	*	7.02	5.14	3.95	3.14	2.56	2.13	1.80	1.55	1.34	
		L/200	7.02	5.14	3.95	3.14	2.26	1.58	1.16	0.87	0.67	
		L/250	7.02	5.14	3.95	2.69	1.81	1.27	0.92	0.69	0.53	
		L/300	7.02	5.14	3.57	2.25	1.50	1.06	0.77	0.58	0.45	
0,88	7,57	*	9.36	6.82	5.22	4.13	3.36	2.79	2.36	2.02	1.75	
		L/200	9.36	6.82	5.22	3.92	2.63	1.84	1.34	1.01	0.78	
		L/250	9.36	6.82	4.98	3.14	2.10	1.48	1.08	0.81	0.62	
		L/300	9.36	6.82	4.15	2.61	1.75	1.23	0.90	0.67	0.52	
1,00	8,61	*	11.74	8.53	6.50	5.14	4.17	3.46	2.92	2.49	2.16	
		L/200	11.74	8.53	6.50	4.42	2.96	2.08	1.52	1.14	0.88	
		L/250	11.74	8.53	5.61	3.53	2.37	1.66	1.21	0.91	0.70	
		L/300	11.74	8.08	4.68	2.95	1.97	1.39	1.01	0.76	0.58	
1,25	10,76	*	16.96	12.21	9.25	7.27	5.87	4.84	4.07	3.47	2.99	
		L/200	16.96	12.21	8.63	5.43	3.64	2.56	1.86	1.40	1.08	
		L/250	16.96	11.93	6.90	4.35	2.91	2.05	1.49	1.12	0.86	
		L/300	16.96	9.94	5.75	3.62	2.43	1.70	1.24	0.93	0.72	
1,50	12,91	*	22.49	16.05	12.07	9.43	7.58	6.23	5.21	4.43	3.81	
		L/200	22.49	16.05	10.18	6.41	4.30	3.02	2.20	1.65	1.27	
		L/250	22.49	14.08	8.15	5.13	3.44	2.41	1.76	1.32	1.02	
		L/300	22.49	11.73	6.79	4.28	2.86	2.01	1.47	1.10	0.85	

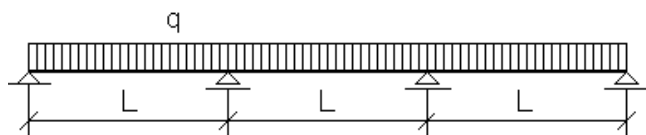

TRAPEZ T - 30 A,eff

Oceľ S 220 GD

t	g	Kritérium pre	Medzné zaťaženie q [kN/m^2] pre rozpätie L [m]									
			1,00	1,25	1,50	1,75	2,00	2,25	2,50	2,75	3,00	
[mm]	[kg/m^2]	* pevnosť δ_{max}										
0,40	3,44	*	2.33	1.75	1.38	1.12	0.93	0.79	0.68	0.59	0.52	
		L/200	2.33	1.75	1.38	1.12	0.80	0.56	0.41	0.31	0.24	
		L/250	2.33	1.75	1.38	0.96	0.64	0.45	0.33	0.25	0.19	
		L/300	2.33	1.75	1.27	0.80	0.53	0.37	0.27	0.21	0.16	
0,50	4,30	*	3.59	2.69	2.10	1.70	1.41	1.18	1.01	0.88	0.77	
		L/200	3.59	2.69	2.10	1.59	1.07	0.75	0.55	0.41	0.32	
		L/250	3.59	2.69	2.03	1.28	0.85	0.60	0.44	0.33	0.25	
		L/300	3.59	2.69	1.69	1.06	0.71	0.50	0.36	0.27	0.21	
0,60	5,16	*	5.07	3.77	2.94	2.36	1.95	1.64	1.40	1.21	1.06	
		L/200	5.07	3.77	2.94	2.02	1.35	0.95	0.69	0.52	0.40	
		L/250	5.07	3.77	2.57	1.62	1.08	0.76	0.55	0.42	0.32	
		L/300	5.07	3.70	2.14	1.35	0.90	0.63	0.46	0.35	0.27	
0,70	6,02	*	6.75	5.00	3.88	3.11	2.56	2.15	1.83	1.58	1.38	
		L/200	6.75	5.00	3.88	2.47	1.66	1.16	0.85	0.64	0.49	
		L/250	6.75	5.00	3.14	1.98	1.33	0.93	0.68	0.51	0.39	
		L/300	6.75	4.52	2.62	1.65	1.10	0.78	0.57	0.42	0.33	
0,75	6,46	*	7.66	5.67	4.39	3.52	2.89	2.42	2.06	1.78	1.55	
		L/200	7.66	5.67	4.25	2.68	1.79	1.26	0.92	0.69	0.53	
		L/250	7.66	5.67	3.40	2.14	1.43	1.01	0.73	0.55	0.42	
		L/300	7.66	4.89	2.83	1.78	1.19	0.84	0.61	0.46	0.35	
0,88	7,57	*	10.24	7.55	5.83	4.66	3.81	3.19	2.71	2.33	2.03	
		L/200	10.24	7.55	4.94	3.11	2.08	1.46	1.07	0.80	0.62	
		L/250	10.24	6.83	3.95	2.49	1.67	1.17	0.85	0.64	0.49	
		L/300	10.24	5.69	3.29	2.07	1.39	0.98	0.71	0.53	0.41	
1,00	8,61	*	12.89	9.46	7.29	5.81	4.75	3.96	3.36	2.88	2.51	
		L/200	12.89	9.46	5.57	3.51	2.35	1.65	1.20	0.90	0.70	
		L/250	12.89	7.70	4.46	2.81	1.88	1.32	0.96	0.72	0.56	
		L/300	12.54	6.42	3.71	2.34	1.57	1.10	0.80	0.60	0.46	
1,25	10,76	*	18.77	13.67	10.45	8.28	6.73	5.59	4.72	4.04	3.50	
		L/200	18.77	11.84	6.85	4.31	2.89	2.03	1.48	1.11	0.86	
		L/250	18.50	9.47	5.48	3.45	2.31	1.62	1.18	0.89	0.69	
		L/300	15.42	7.89	4.57	2.88	1.93	1.35	0.99	0.74	0.57	
1,50	12,91	*	25.08	18.11	13.75	10.83	8.76	7.24	6.09	5.19	4.49	
		L/200	25.08	13.98	8.09	5.09	3.41	2.40	1.75	1.31	1.01	
		L/250	21.84	11.18	6.47	4.07	2.73	1.92	1.40	1.05	0.81	
		L/300	18.20	9.32	5.39	3.40	2.27	1.60	1.16	0.88	0.67	

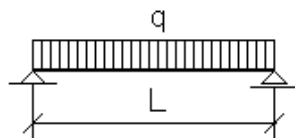

TRAPEZ T - 30 A,eff

Oceľ S 250 GD

t	g	Kritérium pre	Medzné zaťaženie q [kN/m^2] pre rozpätie L [m]									
			[mm]	[kg/m^2]	* pevnosť δ_{max}	1,00	1,25	1,50	1,75	2,00	2,25	2,50
0,40	3,44	*		2.62	1.99	1.38	1.01	0.78	0.61	0.50	0.41	0.34
		L/200		2.62	1.68	0.97	0.61	0.41	0.29	0.21	0.16	0.12
		L/250		2.62	1.34	0.78	0.49	0.33	0.23	0.17	0.13	0.10
		L/300		2.19	1.12	0.65	0.41	0.27	0.19	0.14	0.11	0.08
0,50	4,30	*		4.05	2.68	1.86	1.37	1.05	0.83	0.67	0.55	0.47
		L/200		4.05	2.24	1.30	0.82	0.55	0.38	0.28	0.21	0.16
		L/250		3.50	1.79	1.04	0.65	0.44	0.31	0.22	0.17	0.13
		L/300		2.91	1.49	0.86	0.54	0.36	0.26	0.19	0.14	0.11
0,60	5,16	*		5.38	3.44	2.39	1.76	1.35	1.06	0.86	0.71	0.60
		L/200		5.38	2.84	1.64	1.03	0.69	0.49	0.35	0.27	0.21
		L/250		4.43	2.27	1.31	0.83	0.55	0.39	0.28	0.21	0.16
		L/300		3.69	1.89	1.09	0.69	0.46	0.32	0.24	0.18	0.14
0,70	6,02	*		6.66	4.26	2.96	2.17	1.66	1.32	1.07	0.88	0.74
		L/200		6.66	3.47	2.01	1.26	0.85	0.59	0.43	0.33	0.25
		L/250		5.42	2.77	1.60	1.01	0.68	0.48	0.35	0.26	0.20
		L/300		4.51	2.31	1.34	0.84	0.56	0.40	0.29	0.22	0.17
0,75	6,46	*		7.33	4.69	3.26	2.39	1.83	1.45	1.17	0.97	0.81
		L/200		7.33	3.79	2.19	1.38	0.93	0.65	0.47	0.36	0.27
		L/250		5.93	3.03	1.76	1.11	0.74	0.52	0.38	0.28	0.22
		L/300		4.94	2.53	1.46	0.92	0.62	0.43	0.32	0.24	0.18
0,88	7,57	*		8.65	5.54	3.85	2.83	2.16	1.71	1.38	1.14	0.96
		L/200		8.65	4.46	2.58	1.63	1.09	0.76	0.56	0.42	0.32
		L/250		6.97	3.57	2.06	1.30	0.87	0.61	0.45	0.34	0.26
		L/300		5.81	2.97	1.72	1.08	0.73	0.51	0.37	0.28	0.22
1,00	8,61	*		9.77	6.25	4.34	3.19	2.44	1.93	1.56	1.29	1.09
		L/200		9.77	5.03	2.91	1.83	1.23	0.86	0.63	0.47	0.36
		L/250		7.86	4.02	2.33	1.47	0.98	0.69	0.50	0.38	0.29
		L/300		6.55	3.35	1.94	1.22	0.82	0.57	0.42	0.31	0.24
1,25	10,76	*		12.05	7.71	5.36	3.94	3.01	2.38	1.93	1.59	1.34
		L/200		12.05	6.18	3.58	2.25	1.51	1.06	0.77	0.58	0.45
		L/250		9.66	4.95	2.86	1.80	1.21	0.85	0.62	0.46	0.36
		L/300		8.05	4.12	2.39	1.50	1.01	0.71	0.52	0.39	0.30
1,50	12,91	*		14.27	9.14	6.34	4.66	3.57	2.82	2.28	1.89	1.59
		L/200		14.26	7.30	4.22	2.66	1.78	1.25	0.91	0.69	0.53
		L/250		11.40	5.84	3.38	2.13	1.43	1.00	0.73	0.55	0.42
		L/300		9.50	4.87	2.82	1.77	1.19	0.83	0.61	0.46	0.3

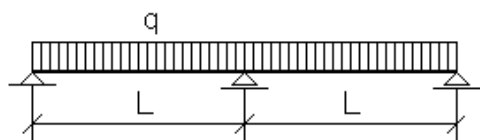

TRAPEZ T - 30 A,eff

Oceľ S 250 GD

t	g	Kritérium pre	Medzné zaťaženie q [kN/m^2] pre rozpätie L [m]									
			[mm]	[kg/m^2]	* pevnosť δ_{max}	1,00	1,25	1,50	1,75	2,00	2,25	2,50
0,40	3,44	*		2.34	1.75	1.37	1.10	0.91	0.77	0.66	0.57	0.50
		$L/200$		2.34	1.75	1.37	1.10	0.91	0.69	0.51	0.38	0.29
		$L/250$		2.34	1.75	1.37	1.10	0.79	0.56	0.40	0.30	0.23
		$L/300$		2.34	1.75	1.37	0.98	0.66	0.46	0.34	0.25	0.20
0,50	4,30	*		3.58	2.66	2.06	1.66	1.36	1.14	0.97	0.84	0.73
		$L/200$		3.58	2.66	2.06	1.66	1.32	0.93	0.67	0.51	0.39
		$L/250$		3.58	2.66	2.06	1.57	1.05	0.74	0.54	0.41	0.31
		$L/300$		3.58	2.66	2.06	1.31	0.88	0.62	0.45	0.34	0.26
0,60	5,16	*		5.03	3.71	2.87	2.29	1.88	1.57	1.34	1.15	1.00
		$L/200$		5.03	3.71	2.87	2.29	1.67	1.17	0.85	0.64	0.49
		$L/250$		5.03	3.71	2.87	1.99	1.34	0.94	0.68	0.51	0.40
		$L/300$		5.03	3.71	2.64	1.66	1.11	0.78	0.57	0.43	0.33
0,70	6,02	*		6.68	4.90	3.78	3.01	2.46	2.05	1.74	1.49	1.30
		$L/200$		6.68	4.90	3.78	3.01	2.04	1.43	1.04	0.78	0.60
		$L/250$		6.68	4.90	3.78	2.44	1.63	1.15	0.84	0.63	0.48
		$L/300$		6.68	4.90	3.22	2.03	1.36	0.96	0.70	0.52	0.40
0,75	6,46	*		7.57	5.55	4.27	3.39	2.77	2.31	1.95	1.68	1.46
		$L/200$		7.57	5.55	4.27	3.33	2.23	1.57	1.14	0.86	0.66
		$L/250$		7.57	5.55	4.23	2.67	1.79	1.25	0.91	0.69	0.53
		$L/300$		7.57	5.55	3.53	2.22	1.49	1.05	0.76	0.57	0.44
0,88	7,57	*		10.09	7.36	5.64	4.47	3.64	3.03	2.56	2.19	1.90
		$L/200$		10.09	7.36	5.64	3.92	2.63	1.84	1.34	1.01	0.78
		$L/250$		10.09	7.36	4.98	3.14	2.10	1.48	1.08	0.81	0.62
		$L/300$		10.09	7.17	4.15	2.61	1.75	1.23	0.90	0.67	0.52
1,00	8,61	*		12.66	9.21	7.03	5.56	4.52	3.75	3.16	2.71	2.34
		$L/200$		12.66	9.21	7.02	4.42	2.96	2.08	1.52	1.14	0.88
		$L/250$		12.66	9.21	5.61	3.53	2.37	1.66	1.21	0.91	0.70
		$L/300$		12.66	8.08	4.68	2.95	1.97	1.39	1.01	0.76	0.58
1,25	10,76	*		18.49	13.34	10.13	7.97	6.45	5.33	4.48	3.82	3.30
		$L/200$		18.49	13.34	8.63	5.43	3.64	2.56	1.86	1.40	1.08
		$L/250$		18.49	11.93	6.90	4.35	2.91	2.05	1.49	1.12	0.86
		$L/300$		18.49	9.94	5.75	3.62	2.43	1.70	1.24	0.93	0.72
1,50	12,91	*		24.54	17.56	13.24	10.36	8.34	6.86	5.75	4.89	4.21
		$L/200$		24.54	17.56	10.18	6.41	4.30	3.02	2.20	1.65	1.27
		$L/250$		24.54	14.08	8.15	5.13	3.44	2.41	1.76	1.32	1.02
		$L/300$		22.92	11.73	6.79	4.28	2.86	2.01	1.47	1.10	0.85

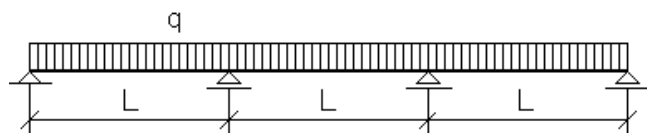

TRAPEZ T - 30 A,eff

Oceľ S 250 GD

<i>t</i>	<i>g</i>	Kritérium pre	Medzné zaťaženie <i>q</i> [kN/m ²] pre rozpätie <i>L</i> [m]									
			[mm]	[kg/m ²]	* pevnosť δ_{max}	1,00	1,25	1,50	1,75	2,00	2,25	2,50
0,40	3,44	*		2,50	1,89	1,49	1,21	1,01	0,85	0,73	0,64	0,56
		<i>L</i> /200		2,50	1,89	1,49	1,17	0,79	0,55	0,40	0,30	0,23
		<i>L</i> /250		2,50	1,89	1,49	0,94	0,63	0,44	0,32	0,24	0,19
		<i>L</i> /300		2,50	1,89	1,24	0,78	0,52	0,37	0,27	0,20	0,16
0,50	4,30	*		3,86	2,89	2,27	1,83	1,52	1,28	1,10	0,95	0,83
		<i>L</i> /200		3,86	2,89	2,27	1,56	1,05	0,73	0,54	0,40	0,31
		<i>L</i> /250		3,86	2,89	1,98	1,25	0,84	0,59	0,43	0,32	0,25
		<i>L</i> /300		3,86	2,86	1,65	1,04	0,70	0,49	0,36	0,27	0,21
0,60	5,16	*		5,45	4,06	3,17	2,55	2,11	1,77	1,51	1,31	1,15
		<i>L</i> /200		5,45	4,06	3,14	1,98	1,33	0,93	0,68	0,51	0,39
		<i>L</i> /250		5,45	4,06	2,51	1,58	1,06	0,74	0,54	0,41	0,31
		<i>L</i> /300		5,45	3,62	2,09	1,32	0,88	0,62	0,45	0,34	0,26
0,70	6,02	*		7,26	5,39	4,19	3,36	2,77	2,32	1,98	1,71	1,49
		<i>L</i> /200		7,26	5,39	3,84	2,42	1,62	1,14	0,83	0,62	0,48
		<i>L</i> /250		7,26	5,31	3,07	1,93	1,30	0,91	0,66	0,50	0,38
		<i>L</i> /300		7,26	4,42	2,56	1,61	1,08	0,76	0,55	0,42	0,32
0,75	6,46	*		8,24	6,10	4,74	3,80	3,12	2,62	2,23	1,92	1,68
		<i>L</i> /200		8,24	6,10	4,20	2,65	1,77	1,25	0,91	0,68	0,53
		<i>L</i> /250		8,24	5,81	3,36	2,12	1,42	1,00	0,73	0,55	0,42
		<i>L</i> /300		8,24	4,84	2,80	1,76	1,18	0,83	0,61	0,45	0,35
0,88	7,57	*		11,02	8,13	6,29	5,03	4,12	3,45	2,93	2,52	2,20
		<i>L</i> /200		11,02	8,13	4,94	3,11	2,08	1,46	1,07	0,80	0,62
		<i>L</i> /250		11,02	6,83	3,95	2,49	1,67	1,17	0,85	0,64	0,49
		<i>L</i> /300		11,02	5,69	3,29	2,07	1,39	0,98	0,71	0,53	0,41
1,00	8,61	*		13,87	10,20	7,87	6,28	5,14	4,29	3,64	3,13	2,72
		<i>L</i> /200		13,87	9,63	5,57	3,51	2,35	1,65	1,20	0,90	0,70
		<i>L</i> /250		13,87	7,70	4,46	2,81	1,88	1,32	0,96	0,72	0,56
		<i>L</i> /300		12,54	6,42	3,71	2,34	1,57	1,10	0,80	0,60	0,46
1,25	10,76	*		20,40	14,90	11,42	9,06	7,38	6,13	5,19	4,44	3,85
		<i>L</i> /200		20,40	11,84	6,85	4,31	2,89	2,03	1,48	1,11	0,86
		<i>L</i> /250		18,50	9,47	5,48	3,45	2,31	1,62	1,18	0,89	0,69
		<i>L</i> /300		15,42	7,89	4,57	2,88	1,93	1,35	0,99	0,74	0,57
1,50	12,91	*		27,30	19,77	15,04	11,87	9,61	7,96	6,70	5,72	4,95
		<i>L</i> /200		27,30	13,98	8,09	5,09	3,41	2,40	1,75	1,31	1,01
		<i>L</i> /250		21,84	11,18	6,47	4,07	2,73	1,92	1,40	1,05	0,81
		<i>L</i> /300		18,20	9,32	5,39	3,40	2,27	1,60	1,16	0,88	0,67

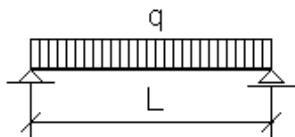

TRAPEZ T - 30 A,eff

Oceľ S 280 GD

<i>t</i>	<i>g</i>	Kritérium pre	Medzné zaťaženie q [kN/m^2] pre rozpätie L [m]									
			[mm]	[kg/m^2]	* pevnosť δ_{max}	1,00	1,25	1,50	1,75	2,00	2,25	2,50
0,40	3,44	*		2.77	2.18	1.51	1.11	0.85	0.67	0.54	0.45	0.38
		$L/200$		2.77	1.65	0.96	0.60	0.40	0.28	0.21	0.16	0.12
		$L/250$		2.58	1.32	0.76	0.48	0.32	0.23	0.17	0.12	0.10
		$L/300$		2.15	1.10	0.64	0.40	0.27	0.19	0.14	0.10	0.08
0,50	4,30	*		4.28	2.94	2.04	1.50	1.15	0.91	0.73	0.61	0.51
		$L/200$		4.28	2.20	1.27	0.80	0.54	0.38	0.27	0.21	0.16
		$L/250$		3.43	1.76	1.02	0.64	0.43	0.30	0.22	0.17	0.13
		$L/300$		2.86	1.46	0.85	0.53	0.36	0.25	0.18	0.14	0.11
0,60	5,16	*		5.89	3.77	2.62	1.92	1.47	1.16	0.94	0.78	0.65
		$L/200$		5.43	2.78	1.61	1.01	0.68	0.48	0.35	0.26	0.20
		$L/250$		4.35	2.23	1.29	0.81	0.54	0.38	0.28	0.21	0.16
		$L/300$		3.62	1.85	1.07	0.68	0.45	0.32	0.23	0.17	0.13
0,70	6,02	*		7.28	4.66	3.24	2.38	1.82	1.44	1.17	0.96	0.81
		$L/200$		6.64	3.40	1.97	1.24	0.83	0.58	0.42	0.32	0.25
		$L/250$		5.31	2.72	1.57	0.99	0.66	0.47	0.34	0.26	0.20
		$L/300$		4.43	2.27	1.31	0.83	0.55	0.39	0.28	0.21	0.16
0,75	6,46	*		8.01	5.13	3.56	2.62	2.00	1.58	1.28	1.06	0.89
		$L/200$		7.26	3.72	2.15	1.35	0.91	0.64	0.46	0.35	0.27
		$L/250$		5.81	2.97	1.72	1.08	0.73	0.51	0.37	0.28	0.22
		$L/300$		4.84	2.48	1.43	0.90	0.61	0.42	0.31	0.23	0.18
0,88	7,57	*		9.69	6.20	4.31	3.16	2.42	1.91	1.55	1.28	1.08
		$L/200$		8.71	4.46	2.58	1.63	1.09	0.76	0.56	0.42	0.32
		$L/250$		6.97	3.57	2.06	1.30	0.87	0.61	0.45	0.34	0.26
		$L/300$		5.81	2.97	1.72	1.08	0.73	0.51	0.37	0.28	0.22
1,00	8,61	*		10.94	7.00	4.86	3.57	2.74	2.16	1.75	1.45	1.22
		$L/200$		9.82	5.03	2.91	1.83	1.23	0.86	0.63	0.47	0.36
		$L/250$		7.86	4.02	2.33	1.47	0.98	0.69	0.50	0.38	0.29
		$L/300$		6.55	3.35	1.94	1.22	0.82	0.57	0.42	0.31	0.24
1,25	10,76	*		13.50	8.64	6.00	4.41	3.37	2.67	2.16	1.79	1.50
		$L/200$		12.08	6.18	3.58	2.25	1.51	1.06	0.77	0.58	0.45
		$L/250$		9.66	4.95	2.86	1.80	1.21	0.85	0.62	0.46	0.36
		$L/300$		8.05	4.12	2.39	1.50	1.01	0.71	0.52	0.39	0.30
1,50	12,91	*		15.99	10.23	7.11	5.22	4.00	3.16	2.56	2.11	1.78
		$L/200$		14.26	7.30	4.22	2.66	1.78	1.25	0.91	0.69	0.53
		$L/250$		11.40	5.84	3.38	2.13	1.43	1.00	0.73	0.55	0.42
		$L/300$		9.50	4.87	2.82	1.77	1.19	0.83	0.61	0.46	0.35

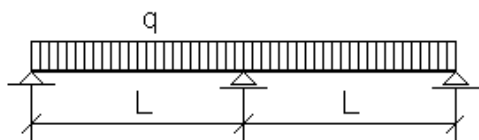

TRAPEZ T - 30 A,eff

Oceľ S 280 GD

t	g	Kritérium pre	Medzné zaťaženie q [kN/m ²] pre rozpätie L [m]									
			1,00	1,25	1,50	1,75	2,00	2,25	2,50	2,75	3,00	
[mm]	[kg/m ²]	* pevnosť δ_{max}										
0,40	3,44	*	2,50	1,87	1,46	1,18	0,98	0,82	0,71	0,61	0,54	
		L/200	2,50	1,87	1,46	1,18	0,97	0,68	0,50	0,37	0,29	
		L/250	2,50	1,87	1,46	1,16	0,78	0,55	0,40	0,30	0,23	
		L/300	2,50	1,87	1,46	0,97	0,65	0,46	0,33	0,25	0,19	
0,50	4,30	*	3,83	2,84	2,21	1,78	1,46	1,23	1,05	0,90	0,79	
		L/200	3,83	2,84	2,21	1,78	1,29	0,91	0,66	0,50	0,38	
		L/250	3,83	2,84	2,21	1,54	1,03	0,73	0,53	0,40	0,31	
		L/300	3,83	2,84	2,04	1,29	0,86	0,61	0,44	0,33	0,26	
0,60	5,16	*	5,38	3,97	3,07	2,46	2,02	1,69	1,44	1,24	1,08	
		L/200	5,38	3,97	3,07	2,44	1,64	1,15	0,84	0,63	0,49	
		L/250	5,38	3,97	3,07	1,96	1,31	0,92	0,67	0,50	0,39	
		L/300	5,38	3,97	2,59	1,63	1,09	0,77	0,56	0,42	0,32	
0,70	6,02	*	7,13	5,25	4,04	3,23	2,64	2,20	1,87	1,61	1,40	
		L/200	7,13	5,25	4,04	2,99	2,00	1,41	1,02	0,77	0,59	
		L/250	7,13	5,25	3,79	2,39	1,60	1,12	0,82	0,62	0,47	
		L/300	7,13	5,25	3,16	1,99	1,33	0,94	0,68	0,51	0,40	
0,75	6,46	*	8,09	5,93	4,57	3,64	2,97	2,48	2,10	1,80	1,57	
		L/200	8,09	5,93	4,57	3,27	2,19	1,54	1,12	0,84	0,65	
		L/250	8,09	5,93	4,15	2,61	1,75	1,23	0,90	0,67	0,52	
		L/300	8,09	5,93	3,46	2,18	1,46	1,02	0,75	0,56	0,43	
0,88	7,57	*	10,78	7,88	6,04	4,80	3,91	3,25	2,75	2,36	2,04	
		L/200	10,78	7,88	6,04	3,92	2,63	1,84	1,34	1,01	0,78	
		L/250	10,78	7,88	4,98	3,14	2,10	1,48	1,08	0,81	0,62	
		L/300	10,78	7,17	4,15	2,61	1,75	1,23	0,90	0,67	0,52	
1,00	8,61	*	13,53	9,85	7,54	5,97	4,85	4,03	3,40	2,91	2,52	
		L/200	13,53	9,85	7,02	4,42	2,96	2,08	1,52	1,14	0,88	
		L/250	13,53	9,70	5,61	3,53	2,37	1,66	1,21	0,91	0,70	
		L/300	13,53	8,08	4,68	2,95	1,97	1,39	1,01	0,76	0,58	
1,25	10,76	*	19,94	14,43	10,98	8,66	7,01	5,80	4,88	4,17	3,60	
		L/200	19,94	14,43	8,63	5,43	3,64	2,56	1,86	1,40	1,08	
		L/250	19,94	11,93	6,90	4,35	2,91	2,05	1,49	1,12	0,86	
		L/300	19,41	9,94	5,75	3,62	2,43	1,70	1,24	0,93	0,72	
1,50	12,91	*	26,51	19,02	14,36	11,26	9,07	7,48	6,27	5,34	4,60	
		L/200	26,51	17,60	10,18	6,41	4,30	3,02	2,20	1,65	1,27	
		L/250	26,51	14,08	8,15	5,13	3,44	2,41	1,76	1,32	1,02	
		L/300	22,92	11,73	6,79	4,28	2,86	2,01	1,47	1,10	0,85	

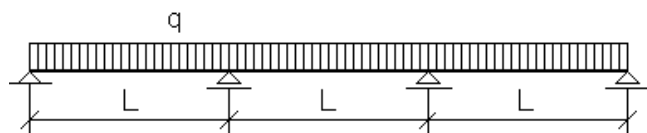

TRAPEZ T - 30 A,eff

Oceľ S 280 GD

<i>t</i>	<i>g</i>	Kritérium pre	Medzné zaťaženie <i>q</i> [kN/m ²] pre rozpätie <i>L</i> [m]									
			[mm]	[kg/m ²]	* pevnosť δ_{max}	1,00	1,25	1,50	1,75	2,00	2,25	2,50
0,40	3,44	*		2.67	2.02	1.59	1.30	1.08	0.92	0.79	0.69	0.60
		L/200		2.67	2.02	1.59	1.15	0.77	0.54	0.40	0.30	0.23
		L/250		2.67	2.02	1.46	0.92	0.62	0.43	0.32	0.24	0.18
		L/300		2.67	2.02	1.22	0.77	0.51	0.36	0.26	0.20	0.15
0,50	4,30	*		4.12	3.09	2.42	1.96	1.63	1.37	1.18	1.02	0.90
		L/200		4.12	3.09	2.42	1.53	1.03	0.72	0.53	0.40	0.30
		L/250		4.12	3.09	1.95	1.23	0.82	0.58	0.42	0.32	0.24
		L/300		4.12	2.80	1.62	1.02	0.68	0.48	0.35	0.26	0.20
0,60	5,16	*		5.81	4.34	3.39	2.73	2.26	1.90	1.62	1.41	1.23
		L/200		5.81	4.34	3.08	1.94	1.30	0.91	0.67	0.50	0.39
		L/250		5.81	4.26	2.47	1.55	1.04	0.73	0.53	0.40	0.31
		L/300		5.81	3.55	2.05	1.29	0.87	0.61	0.44	0.33	0.26
0,70	6,02	*		7.74	5.75	4.48	3.60	2.97	2.49	2.12	1.84	1.60
		L/200		7.74	5.75	3.77	2.37	1.59	1.12	0.81	0.61	0.47
		L/250		7.74	5.21	3.01	1.90	1.27	0.89	0.65	0.49	0.38
		L/300		7.74	4.34	2.51	1.58	1.06	0.74	0.54	0.41	0.31
0,75	6,46	*		8.79	6.52	5.07	4.07	3.35	2.81	2.39	2.07	1.80
		L/200		8.79	6.52	4.12	2.59	1.74	1.22	0.89	0.67	0.51
		L/250		8.79	5.69	3.30	2.08	1.39	0.98	0.71	0.53	0.41
		L/300		8.79	4.75	2.75	1.73	1.16	0.81	0.59	0.45	0.34
0,88	7,57	*		11.76	8.69	6.73	5.39	4.42	3.70	3.15	2.71	2.36
		L/200		11.76	8.54	4.94	3.11	2.08	1.46	1.07	0.80	0.62
		L/250		11.76	6.83	3.95	2.49	1.67	1.17	0.85	0.64	0.49
		L/300		11.12	5.69	3.29	2.07	1.39	0.98	0.71	0.53	0.41
1,00	8,61	*		14.81	10.91	8.42	6.72	5.51	4.60	3.90	3.36	2.92
		L/200		14.81	9.63	5.57	3.51	2.35	1.65	1.20	0.90	0.70
		L/250		14.81	7.70	4.46	2.81	1.88	1.32	0.96	0.72	0.56
		L/300		12.54	6.42	3.71	2.34	1.57	1.10	0.80	0.60	0.46
1,25	10,76	*		21.96	16.07	12.34	9.81	8.00	6.66	5.64	4.84	4.20
		L/200		21.96	11.84	6.85	4.31	2.89	2.03	1.48	1.11	0.86
		L/250		18.50	9.47	5.48	3.45	2.31	1.62	1.18	0.89	0.69
		L/300		15.42	7.89	4.57	2.88	1.93	1.35	0.99	0.74	0.57
1,50	12,91	*		29.42	21.36	16.29	12.87	10.44	8.65	7.29	6.24	5.39
		L/200		27.30	13.98	8.09	5.09	3.41	2.40	1.75	1.31	1.01
		L/250		21.84	11.18	6.47	4.07	2.73	1.92	1.40	1.05	0.81
		L/300		18.20	9.32	5.39	3.40	2.27	1.60	1.16	0.88	0.67

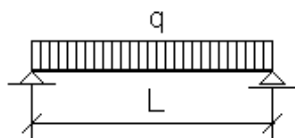

TRAPEZ T - 30 A,eff

Oceľ S 320 GD

<i>t</i>	<i>g</i>	Kritérium pre	Medzné zaťaženie <i>q</i> [kN/m ²] pre rozpätie <i>L</i> [m]									
			[mm]	[kg/m ²]	* pevnosť δ_{max}	1,00	1,25	1,50	1,75	2,00	2,25	2,50
0,40	3,44	*		2.96	2.37	1.69	1.24	0.95	0.75	0.61	0.50	0.42
		<i>L</i> /200		2.96	1.62	0.94	0.59	0.40	0.28	0.20	0.15	0.12
		<i>L</i> /250		2.53	1.30	0.75	0.47	0.32	0.22	0.16	0.12	0.09
		<i>L</i> /300		2.11	1.08	0.62	0.39	0.26	0.19	0.13	0.10	0.08
0,50	4,30	*		4.58	3.28	2.28	1.67	1.28	1.01	0.82	0.68	0.57
		<i>L</i> /200		4.20	2.15	1.24	0.78	0.53	0.37	0.27	0.20	0.16
		<i>L</i> /250		3.36	1.72	1.00	0.63	0.42	0.30	0.22	0.16	0.12
		<i>L</i> /300		2.80	1.43	0.83	0.52	0.35	0.25	0.18	0.13	0.10
0,60	5,16	*		6.54	4.19	2.91	2.14	1.64	1.29	1.05	0.87	0.73
		<i>L</i> /200		5.31	2.72	1.57	0.99	0.66	0.47	0.34	0.26	0.20
		<i>L</i> /250		4.25	2.18	1.26	0.79	0.53	0.37	0.27	0.20	0.16
		<i>L</i> /300		3.54	1.81	1.05	0.66	0.44	0.31	0.23	0.17	0.13
0,70	6,02	*		8.09	5.18	3.60	2.64	2.02	1.60	1.30	1.07	0.90
		<i>L</i> /200		6.49	3.32	1.92	1.21	0.81	0.57	0.42	0.31	0.24
		<i>L</i> /250		5.19	2.66	1.54	0.97	0.65	0.46	0.33	0.25	0.19
		<i>L</i> /300		4.32	2.21	1.28	0.81	0.54	0.38	0.28	0.21	0.16
0,75	6,46	*		8.90	5.70	3.96	2.91	2.23	1.76	1.42	1.18	0.99
		<i>L</i> /200		7.09	3.63	2.10	1.32	0.89	0.62	0.45	0.34	0.26
		<i>L</i> /250		5.68	2.91	1.68	1.06	0.71	0.50	0.36	0.27	0.21
		<i>L</i> /300		4.73	2.42	1.40	0.88	0.59	0.42	0.30	0.23	0.18
0,88	7,57	*		11.08	7.09	4.92	3.62	2.77	2.19	1.77	1.46	1.23
		<i>L</i> /200		8.71	4.46	2.58	1.63	1.09	0.76	0.56	0.42	0.32
		<i>L</i> /250		6.97	3.57	2.06	1.30	0.87	0.61	0.45	0.34	0.26
		<i>L</i> /300		5.81	2.97	1.72	1.08	0.73	0.51	0.37	0.28	0.22
1,00	8,61	*		12.51	8.00	5.56	4.08	3.13	2.47	2.00	1.65	1.39
		<i>L</i> /200		9.82	5.03	2.91	1.83	1.23	0.86	0.63	0.47	0.36
		<i>L</i> /250		7.86	4.02	2.33	1.47	0.98	0.69	0.50	0.38	0.29
		<i>L</i> /300		6.55	3.35	1.94	1.22	0.82	0.57	0.42	0.31	0.24
1,25	10,76	*		15.43	9.87	6.86	5.04	3.86	3.05	2.47	2.04	1.71
		<i>L</i> /200		12.08	6.18	3.58	2.25	1.51	1.06	0.77	0.58	0.45
		<i>L</i> /250		9.66	4.95	2.86	1.80	1.21	0.85	0.62	0.46	0.36
		<i>L</i> /300		8.05	4.12	2.39	1.50	1.01	0.71	0.52	0.39	0.30
1,50	12,91	*		18.27	11.69	8.12	5.97	4.57	3.61	2.92	2.42	2.03
		<i>L</i> /200		14.26	7.30	4.22	2.66	1.78	1.25	0.91	0.69	0.53
		<i>L</i> /250		11.40	5.84	3.38	2.13	1.43	1.00	0.73	0.55	0.42
		<i>L</i> /300		9.50	4.87	2.82	1.77	1.19	0.83	0.61	0.46	0.35

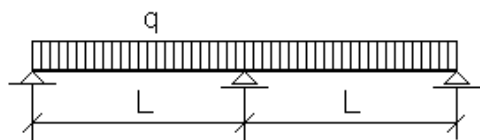

TRAPEZ T - 30 A,eff

Oceľ S 320 GD

t	g	Kritérium pre δ_{max}	Medzné zaťaženie q [kN/m ²] pre rozpätie L [m]									
			1,00	1,25	1,50	1,75	2,00	2,25	2,50	2,75	3,00	
[mm]	[kg/m ²]	* pevnosť δ_{max}										
0,40	3,44	*	2.70	2.02	1.58	1.28	1.06	0.90	0.77	0.67	0.58	
		L/200	2.70	2.02	1.58	1.28	0.95	0.67	0.49	0.37	0.28	
		L/250	2.70	2.02	1.58	1.14	0.76	0.54	0.39	0.29	0.23	
		L/300	2.70	2.02	1.51	0.95	0.64	0.45	0.33	0.24	0.19	
0,50	4,30	*	4.13	3.08	2.40	1.93	1.59	1.33	1.14	0.98	0.86	
		L/200	4.13	3.08	2.40	1.89	1.27	0.89	0.65	0.49	0.38	
		L/250	4.13	3.08	2.40	1.51	1.01	0.71	0.52	0.39	0.30	
		L/300	4.13	3.08	2.00	1.26	0.84	0.59	0.43	0.32	0.25	
0,60	5,16	*	5.81	4.30	3.33	2.67	2.19	1.84	1.56	1.35	1.17	
		L/200	5.81	4.30	3.33	2.39	1.60	1.12	0.82	0.62	0.47	
		L/250	5.81	4.30	3.04	1.91	1.28	0.90	0.66	0.49	0.38	
		L/300	5.81	4.30	2.53	1.59	1.07	0.75	0.55	0.41	0.32	
0,70	6,02	*	7.71	5.68	4.38	3.50	2.87	2.40	2.03	1.75	1.52	
		L/200	7.71	5.68	4.38	2.92	1.96	1.37	1.00	0.75	0.58	
		L/250	7.71	5.68	3.71	2.33	1.56	1.10	0.80	0.60	0.46	
		L/300	7.71	5.34	3.09	1.95	1.30	0.92	0.67	0.50	0.39	
0,75	6,46	*	8.74	6.43	4.95	3.95	3.23	2.70	2.29	1.97	1.71	
		L/200	8.74	6.43	4.95	3.19	2.14	1.50	1.09	0.82	0.63	
		L/250	8.74	6.43	4.05	2.55	1.71	1.20	0.88	0.66	0.51	
		L/300	8.74	5.84	3.38	2.13	1.43	1.00	0.73	0.55	0.42	
0,88	7,57	*	11.65	8.53	6.55	5.21	4.25	3.54	2.99	2.57	2.23	
		L/200	11.65	8.53	6.22	3.92	2.63	1.84	1.34	1.01	0.78	
		L/250	11.65	8.53	4.98	3.14	2.10	1.48	1.08	0.81	0.62	
		L/300	11.65	7.17	4.15	2.61	1.75	1.23	0.90	0.67	0.52	
1,00	8,61	*	14.63	10.67	8.17	6.48	5.28	4.38	3.70	3.17	2.75	
		L/200	14.63	10.67	7.02	4.42	2.96	2.08	1.52	1.14	0.88	
		L/250	14.63	9.70	5.61	3.53	2.37	1.66	1.21	0.91	0.70	
		L/300	14.63	8.08	4.68	2.95	1.97	1.39	1.01	0.76	0.58	
1,25	10,76	*	21.64	15.69	11.96	9.44	7.65	6.34	5.34	4.57	3.95	
		L/200	21.64	14.91	8.63	5.43	3.64	2.56	1.86	1.40	1.08	
		L/250	21.64	11.93	6.90	4.35	2.91	2.05	1.49	1.12	0.86	
		L/300	19.41	9.94	5.75	3.62	2.43	1.70	1.24	0.93	0.72	
1,50	12,91	*	29.02	20.88	15.81	12.41	10.02	8.27	6.94	5.92	5.10	
		L/200	29.02	17.60	10.18	6.41	4.30	3.02	2.20	1.65	1.27	
		L/250	27.50	14.08	8.15	5.13	3.44	2.41	1.76	1.32	1.02	
		L/300	22.92	11.73	6.79	4.28	2.86	2.01	1.47	1.10	0.85	

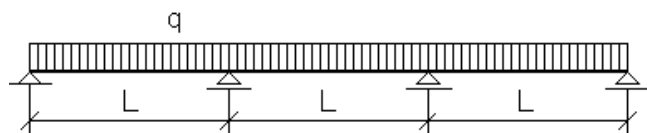

TRAPEZ T - 30 A,eff

Oceľ S 320 GD

t	g	Kritérium pre	Medzné zaťaženie q [kN/m ²] pre rozpätie L [m]									
			1,00	1,25	1,50	1,75	2,00	2,25	2,50	2,75	3,00	
[mm]	[kg/m ²]	* pevnosť δ_{max}										
		*	2.88	2.18	1.72	1.40	1.17	0.99	0.86	0.75	0.66	
0,40	3,44	L/200	2.88	2.18	1.72	1.13	0.76	0.53	0.39	0.29	0.22	
		L/250	2.88	2.18	1.44	0.90	0.61	0.43	0.31	0.23	0.18	
		L/300	2.88	2.07	1.20	0.75	0.50	0.35	0.26	0.19	0.15	
		*	4.44	3.34	2.62	2.13	1.76	1.49	1.28	1.11	0.98	
0,50	4,30	L/200	4.44	3.34	2.38	1.50	1.01	0.71	0.51	0.39	0.30	
		L/250	4.44	3.30	1.91	1.20	0.80	0.57	0.41	0.31	0.24	
		L/300	4.44	2.75	1.59	1.00	0.67	0.47	0.34	0.26	0.20	
		*	6.27	4.69	3.67	2.96	2.45	2.06	1.77	1.53	1.34	
0,60	5,16	L/200	6.27	4.69	3.01	1.90	1.27	0.89	0.65	0.49	0.38	
		L/250	6.27	4.17	2.41	1.52	1.02	0.71	0.52	0.39	0.30	
		L/300	6.27	3.47	2.01	1.27	0.85	0.60	0.43	0.33	0.25	
		*	8.36	6.22	4.85	3.90	3.22	2.70	2.31	2.00	1.74	
0,70	6,02	L/200	8.36	6.22	3.68	2.32	1.55	1.09	0.79	0.60	0.46	
		L/250	8.36	5.09	2.94	1.85	1.24	0.87	0.64	0.48	0.37	
		L/300	8.28	4.24	2.45	1.55	1.04	0.73	0.53	0.40	0.31	
		*	9.49	7.05	5.48	4.41	3.63	3.05	2.60	2.25	1.96	
0,75	6,46	L/200	9.49	6.96	4.02	2.53	1.70	1.19	0.87	0.65	0.50	
		L/250	9.49	5.56	3.22	2.03	1.36	0.95	0.70	0.52	0.40	
		L/300	9.06	4.64	2.68	1.69	1.13	0.80	0.58	0.44	0.34	
		*	12.70	9.40	7.29	5.84	4.80	4.02	3.42	2.95	2.57	
0,88	7,57	L/200	12.70	8.54	4.94	3.11	2.08	1.46	1.07	0.80	0.62	
		L/250	12.70	6.83	3.95	2.49	1.67	1.17	0.85	0.64	0.49	
		L/300	11.12	5.69	3.29	2.07	1.39	0.98	0.71	0.53	0.41	
		*	15.99	11.80	9.12	7.29	5.98	5.00	4.24	3.65	3.18	
1,00	8,61	L/200	15.99	9.63	5.57	3.51	2.35	1.65	1.20	0.90	0.70	
		L/250	15.04	7.70	4.46	2.81	1.88	1.32	0.96	0.72	0.56	
		L/300	12.54	6.42	3.71	2.34	1.57	1.10	0.80	0.60	0.46	
		*	23.79	17.44	13.42	10.68	8.72	7.27	6.16	5.29	4.59	
1,25	10,76	L/200	23.12	11.84	6.85	4.31	2.89	2.03	1.48	1.11	0.86	
		L/250	18.50	9.47	5.48	3.45	2.31	1.62	1.18	0.89	0.69	
		L/300	15.42	7.89	4.57	2.88	1.93	1.35	0.99	0.74	0.57	
		*	32.12	23.38	17.87	14.15	11.50	9.55	8.06	6.90	5.97	
1,50	12,91	L/200	27.30	13.98	8.09	5.09	3.41	2.40	1.75	1.31	1.01	
		L/250	21.84	11.18	6.47	4.07	2.73	1.92	1.40	1.05	0.81	
		L/300	18.20	9.32	5.39	3.40	2.27	1.60	1.16	0.88	0.67	
		*										

3.2 TRAPÉZ T- 30 B,eff

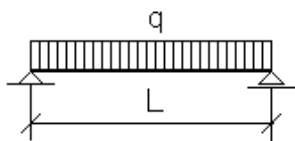

TRAPEZ T - 30 B,eff

Oceľ S 220 GD

t	g	Kritérium pre	Medzné zaťaženie q [kN/m^2] pre rozpätie L [m]										
			$[mm]$	$[kg/m^2]$	* pevnosť δ_{max}	1,00	1,25	1,50	1,75	2,00	2,25	2,50	2,75
0,40	3,44	*			2.45	1.96	1.64	1.40	1.23	1.09	0.96	0.79	0.66
		$L/200$			2.45	1.65	0.95	0.60	0.40	0.28	0.21	0.15	0.12
		$L/250$			2.45	1.37	0.79	0.50	0.33	0.23	0.17	0.13	0.10
		$L/300$			2.15	1.10	0.64	0.40	0.27	0.19	0.14	0.10	0.08
0,50	4,30	*			3.80	3.04	2.53	2.17	1.90	1.63	1.32	1.09	0.92
		$L/200$			3.80	2.15	1.24	0.78	0.52	0.37	0.27	0.20	0.16
		$L/250$			3.57	1.83	1.06	0.67	0.45	0.31	0.23	0.17	0.13
		$L/300$			2.80	1.43	0.83	0.52	0.35	0.25	0.18	0.13	0.10
0,60	5,16	*			5.42	4.34	3.62	3.10	2.71	2.14	1.73	1.43	1.20
		$L/200$			5.20	2.66	1.54	0.97	0.65	0.46	0.33	0.25	0.19
		$L/250$			4.53	2.32	1.34	0.84	0.57	0.40	0.29	0.22	0.17
		$L/300$			3.47	1.78	1.03	0.65	0.43	0.30	0.22	0.17	0.13
0,70	6,02	*			7.34	5.87	4.89	4.19	3.40	2.69	2.18	1.80	1.51
		$L/200$			6.23	3.19	1.85	1.16	0.78	0.55	0.40	0.30	0.23
		$L/250$			5.54	2.84	1.64	1.03	0.69	0.49	0.35	0.27	0.21
		$L/300$			4.15	2.13	1.23	0.78	0.52	0.36	0.27	0.20	0.15
0,75	6,46	*			8.41	6.73	5.61	4.81	3.77	2.98	2.41	2.00	1.68
		$L/200$			6.75	3.46	2.00	1.26	0.84	0.59	0.43	0.32	0.25
		$L/250$			5.99	3.07	1.77	1.12	0.75	0.53	0.38	0.29	0.22
		$L/300$			4.50	2.30	1.33	0.84	0.56	0.40	0.29	0.22	0.17
0,88	7,57	*			11.55	9.24	7.70	6.25	4.78	3.78	3.06	2.53	2.13
		$L/200$			8.12	4.16	2.40	1.51	1.01	0.71	0.52	0.39	0.30
		$L/250$			6.97	3.57	2.06	1.30	0.87	0.61	0.45	0.34	0.26
		$L/300$			5.41	2.77	1.60	1.01	0.68	0.48	0.35	0.26	0.20
1,00	8,61	*			14.94	11.95	9.96	7.54	5.78	4.56	3.70	3.06	2.57
		$L/200$			9.39	4.81	2.78	1.75	1.17	0.82	0.60	0.45	0.35
		$L/250$			7.86	4.02	2.33	1.47	0.98	0.69	0.50	0.38	0.29
		$L/300$			6.26	3.20	1.85	1.17	0.78	0.55	0.40	0.30	0.23
1,25	10,76	*			23.63	18.91	13.54	9.95	7.62	6.02	4.87	4.03	3.38
		$L/200$			11.85	6.07	3.51	2.21	1.48	1.04	0.76	0.57	0.44
		$L/250$			9.66	4.95	2.86	1.80	1.21	0.85	0.62	0.46	0.36
		$L/300$			7.90	4.04	2.34	1.47	0.99	0.69	0.51	0.38	0.29
1,50	12,91	*			34.84	23.79	16.52	12.14	9.29	7.34	5.95	4.92	4.13
		$L/200$			14.18	7.26	4.20	2.65	1.77	1.24	0.91	0.68	0.53
		$L/250$			11.40	5.84	3.38	2.13	1.43	1.00	0.73	0.55	0.42
		$L/300$			9.45	4.84	2.80	1.76	1.18	0.83	0.60	0.45	0.35

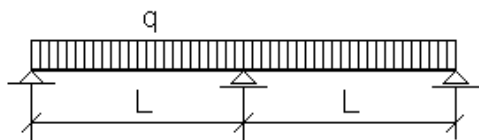

TRAPEZ T - 30 B,eff

Oceľ S 220 GD

t	g	Kritérium pre	Medzné zaťaženie q [kN/m^2] pre rozpätie L [m]									
			1,00	1,25	1,50	1,75	2,00	2,25	2,50	2,75	3,00	
[mm]	[kg/m^2]	* pevnosť δ_{max}										
0,40	3,44	*	1.63	1.17	0.88	0.69	0.56	0.46	0.38	0.33	0.28	
		L/200	1.63	1.17	0.88	0.69	0.56	0.46	0.38	0.33	0.28	
		L/250	1.63	1.17	0.88	0.69	0.56	0.46	0.38	0.30	0.23	
		L/300	1.63	1.17	0.88	0.69	0.56	0.45	0.33	0.25	0.19	
0,50	4,30	*	2.41	1.71	1.28	1.00	0.80	0.65	0.55	0.46	0.40	
		L/200	2.41	1.71	1.28	1.00	0.80	0.65	0.55	0.46	0.37	
		L/250	2.41	1.71	1.28	1.00	0.80	0.65	0.52	0.39	0.30	
		L/300	2.41	1.71	1.28	1.00	0.80	0.59	0.43	0.32	0.25	
0,60	5,16	*	3.28	2.31	1.72	1.33	1.07	0.87	0.73	0.61	0.53	
		L/200	3.28	2.31	1.72	1.33	1.07	0.87	0.73	0.60	0.46	
		L/250	3.28	2.31	1.72	1.33	1.07	0.87	0.64	0.48	0.37	
		L/300	3.28	2.31	1.72	1.33	1.05	0.73	0.54	0.40	0.31	
0,70	6,02	*	4.25	2.98	2.21	1.71	1.36	1.11	0.92	0.78	0.67	
		L/200	4.25	2.98	2.21	1.71	1.36	1.11	0.92	0.72	0.56	
		L/250	4.25	2.98	2.21	1.71	1.36	1.06	0.77	0.58	0.45	
		L/300	4.25	2.98	2.21	1.71	1.25	0.88	0.64	0.48	0.37	
0,75	6,46	*	4.72	3.30	2.44	1.88	1.50	1.22	1.01	0.85	0.73	
		L/200	4.72	3.30	2.44	1.88	1.50	1.22	1.01	0.78	0.60	
		L/250	4.72	3.30	2.44	1.88	1.50	1.14	0.83	0.63	0.48	
		L/300	4.72	3.30	2.44	1.88	1.36	0.95	0.69	0.52	0.40	
0,88	7,57	*	5.88	4.07	2.99	2.30	1.82	1.47	1.22	1.03	0.88	
		L/200	5.88	4.07	2.99	2.30	1.82	1.47	1.22	0.94	0.72	
		L/250	5.88	4.07	2.99	2.30	1.82	1.37	1.00	0.75	0.58	
		L/300	5.88	4.07	2.99	2.30	1.63	1.15	0.84	0.63	0.48	
1,00	8,61	*	6.96	4.79	3.51	2.68	2.11	1.71	1.41	1.19	1.01	
		L/200	6.96	4.79	3.51	2.68	2.11	1.71	1.41	1.09	0.84	
		L/250	6.96	4.79	3.51	2.68	2.11	1.59	1.16	0.87	0.67	
		L/300	6.96	4.79	3.51	2.68	1.89	1.32	0.97	0.73	0.56	
1,25	10,76	*	9.25	6.30	4.57	3.47	2.72	2.20	1.81	1.51	1.29	
		L/200	9.25	6.30	4.57	3.47	2.72	2.20	1.81	1.37	1.06	
		L/250	9.25	6.30	4.57	3.47	2.72	2.01	1.46	1.10	0.85	
		L/300	9.25	6.30	4.57	3.47	2.38	1.67	1.22	0.92	0.71	
1,50	12,91	*	11.54	7.80	5.63	4.25	3.33	2.67	2.20	1.84	1.56	
		L/200	11.54	7.80	5.63	4.25	3.33	2.67	2.19	1.64	1.27	
		L/250	11.54	7.80	5.63	4.25	3.33	2.40	1.75	1.32	1.01	
		L/300	11.54	7.80	5.63	4.25	2.85	2.00	1.46	1.10	0.84	

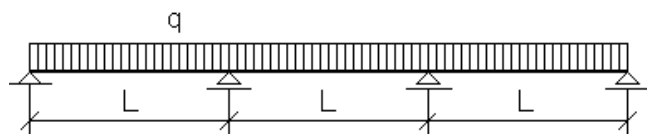

TRAPEZ T - 30 B,eff

Oceľ S 220 GD

t	g	Kritérium pre δ_{max}	Medzné zaťaženie q [kN/m^2] pre rozpätie L [m]								
			1,00	1,25	1,50	1,75	2,00	2,25	2,50	2,75	3,00
0,40	3,44	*	1.81	1.31	1.00	0.79	0.64	0.53	0.45	0.38	0.33
		$L/200$	1.81	1.31	1.00	0.79	0.64	0.53	0.39	0.30	0.23
		$L/250$	1.81	1.31	1.00	0.79	0.62	0.43	0.32	0.24	0.18
		$L/300$	1.81	1.31	1.00	0.77	0.51	0.36	0.26	0.20	0.15
0,50	4,30	*	2.70	1.94	1.47	1.15	0.93	0.76	0.64	0.55	0.47
		$L/200$	2.70	1.94	1.47	1.15	0.93	0.71	0.51	0.39	0.30
		$L/250$	2.70	1.94	1.47	1.15	0.80	0.56	0.41	0.31	0.24
		$L/300$	2.70	1.94	1.47	1.00	0.67	0.47	0.34	0.26	0.20
0,60	5,16	*	3.70	2.64	1.99	1.55	1.25	1.02	0.86	0.73	0.63
		$L/200$	3.70	2.64	1.99	1.55	1.25	0.87	0.64	0.48	0.37
		$L/250$	3.70	2.64	1.99	1.49	1.00	0.70	0.51	0.38	0.30
		$L/300$	3.70	2.64	1.97	1.24	0.83	0.58	0.43	0.32	0.25
0,70	6,02	*	4.82	3.42	2.56	1.99	1.59	1.31	1.09	0.92	0.79
		$L/200$	4.82	3.42	2.56	1.99	1.49	1.05	0.76	0.57	0.44
		$L/250$	4.82	3.42	2.56	1.78	1.19	0.84	0.61	0.46	0.35
		$L/300$	4.82	3.42	2.36	1.48	0.99	0.70	0.51	0.38	0.29
0,75	6,46	*	5.37	3.80	2.84	2.20	1.76	1.44	1.20	1.02	0.87
		$L/200$	5.37	3.80	2.84	2.20	1.62	1.13	0.83	0.62	0.48
		$L/250$	5.37	3.80	2.84	1.93	1.29	0.91	0.66	0.50	0.38
		$L/300$	5.37	3.80	2.55	1.61	1.08	0.76	0.55	0.41	0.32
0,88	7,57	*	6.75	4.73	3.50	2.70	2.15	1.75	1.46	1.23	1.05
		$L/200$	6.75	4.73	3.50	2.70	1.94	1.36	0.99	0.75	0.58
		$L/250$	6.75	4.73	3.50	2.32	1.55	1.09	0.80	0.60	0.46
		$L/300$	6.75	4.73	3.07	1.93	1.30	0.91	0.66	0.50	0.38
1,00	8,61	*	8.04	5.60	4.13	3.17	2.52	2.04	1.70	1.43	1.22
		$L/200$	8.04	5.60	4.13	3.17	2.25	1.58	1.15	0.86	0.67
		$L/250$	8.04	5.60	4.13	2.68	1.80	1.26	0.92	0.69	0.53
		$L/300$	8.04	5.60	3.55	2.24	1.50	1.05	0.77	0.58	0.44
1,25	10,76	*	10.80	7.43	5.43	4.14	3.27	2.65	2.18	1.83	1.56
		$L/200$	10.80	7.43	5.43	4.14	2.84	1.99	1.45	1.09	0.84
		$L/250$	10.80	7.43	5.38	3.39	2.27	1.59	1.16	0.87	0.67
		$L/300$	10.80	7.43	4.48	2.82	1.89	1.33	0.97	0.73	0.56
1,50	12,91	*	13.59	9.26	6.73	5.11	4.01	3.24	2.67	2.23	1.90
		$L/200$	13.59	9.26	6.73	5.07	3.39	2.38	1.74	1.31	1.01
		$L/250$	13.59	9.26	6.44	4.05	2.72	1.91	1.39	1.04	0.80
		$L/300$	13.59	9.26	5.36	3.38	2.26	1.59	1.16	0.87	0.67

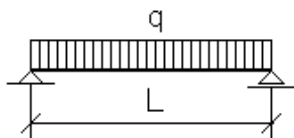

TRAPEZ T - 30 B,eff

Oceľ S 250 GD

t	g	Kritérium pre	Medzné zaťaženie q [kN/m^2] pre rozpätie L [m]									
			[mm]	[kg/m^2]	* pevnosť δ_{max}	1,00	1,25	1,50	1,75	2,00	2,25	2,50
0,40	3,44	*		2.62	2.09	1.74	1.50	1.31	1.16	1.05	0.87	0.73
		L/200		2.62	1.63	0.94	0.59	0.40	0.28	0.20	0.15	0.12
		L/250		2.62	1.34	0.78	0.49	0.33	0.23	0.17	0.13	0.10
		L/300		2.12	1.08	0.63	0.40	0.26	0.19	0.14	0.10	0.08
0,50	4,30	*		4.05	3.24	2.70	2.31	2.02	1.80	1.46	1.20	1.01
		L/200		4.05	2.12	1.23	0.77	0.52	0.36	0.26	0.20	0.15
		L/250		3.50	1.79	1.04	0.65	0.44	0.31	0.22	0.17	0.13
		L/300		2.76	1.41	0.82	0.51	0.34	0.24	0.18	0.13	0.10
0,60	5,16	*		5.78	4.63	3.85	3.30	2.89	2.35	1.90	1.57	1.32
		L/200		5.13	2.63	1.52	0.96	0.64	0.45	0.33	0.25	0.19
		L/250		4.43	2.27	1.31	0.83	0.55	0.39	0.28	0.21	0.16
		L/300		3.42	1.75	1.01	0.64	0.43	0.30	0.22	0.16	0.13
0,70	6,02	*		7.82	6.26	5.22	4.47	3.74	2.95	2.39	1.98	1.66
		L/200		6.15	3.15	1.82	1.15	0.77	0.54	0.39	0.30	0.23
		L/250		5.42	2.77	1.60	1.01	0.68	0.48	0.35	0.26	0.20
		L/300		4.10	2.10	1.21	0.76	0.51	0.36	0.26	0.20	0.15
0,75	6,46	*		8.96	7.17	5.98	5.12	4.14	3.27	2.65	2.19	1.84
		L/200		6.66	3.41	1.97	1.24	0.83	0.58	0.43	0.32	0.25
		L/250		5.93	3.03	1.76	1.11	0.74	0.52	0.38	0.28	0.22
		L/300		4.44	2.27	1.32	0.83	0.56	0.39	0.28	0.21	0.16
0,88	7,57	*		12.31	9.85	8.21	6.85	5.24	4.14	3.36	2.77	2.33
		L/200		8.01	4.10	2.37	1.50	1.00	0.70	0.51	0.39	0.30
		L/250		6.97	3.57	2.06	1.30	0.87	0.61	0.45	0.34	0.26
		L/300		5.34	2.74	1.58	1.00	0.67	0.47	0.34	0.26	0.20
1,00	8,61	*		15.92	12.74	10.62	8.27	6.33	5.00	4.05	3.35	2.81
		L/200		9.27	4.75	2.75	1.73	1.16	0.81	0.59	0.45	0.34
		L/250		7.86	4.02	2.33	1.47	0.98	0.69	0.50	0.38	0.29
		L/300		6.18	3.16	1.83	1.15	0.77	0.54	0.40	0.30	0.23
1,25	10,76	*		25.19	20.15	15.18	11.15	8.54	6.74	5.46	4.51	3.79
		L/200		11.79	6.04	3.49	2.20	1.47	1.04	0.75	0.57	0.44
		L/250		9.66	4.95	2.86	1.80	1.21	0.85	0.62	0.46	0.36
		L/300		7.86	4.03	2.33	1.47	0.98	0.69	0.50	0.38	0.29
1,50	12,91	*		37.14	26.64	18.50	13.59	10.41	8.22	6.66	5.50	4.63
		L/200		14.11	7.23	4.18	2.63	1.76	1.24	0.90	0.68	0.52
		L/250		11.40	5.84	3.38	2.13	1.43	1.00	0.73	0.55	0.42
		L/300		9.41	4.82	2.79	1.76	1.18	0.83	0.60	0.45	0.35

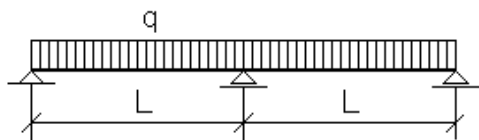

TRAPEZ T - 30 B,eff

Oceľ S 250 GD

t	g	Kritérium pre	Medzné zaťaženie q [kN/m^2] pre rozpätie L [m]									
			1,00	1,25	1,50	1,75	2,00	2,25	2,50	2,75	3,00	
[mm]	[kg/m^2]	* pevnosť δ_{max}										
0,40	3,44	*	1,77	1,27	0,96	0,75	0,61	0,50	0,42	0,36	0,31	
		L/200	1,77	1,27	0,96	0,75	0,61	0,50	0,42	0,36	0,28	
		L/250	1,77	1,27	0,96	0,75	0,61	0,50	0,39	0,29	0,23	
		L/300	1,77	1,27	0,96	0,75	0,61	0,45	0,33	0,25	0,19	
0,50	4,30	*	2,62	1,86	1,40	1,09	0,87	0,72	0,60	0,51	0,44	
		L/200	2,62	1,86	1,40	1,09	0,87	0,72	0,60	0,48	0,37	
		L/250	2,62	1,86	1,40	1,09	0,87	0,70	0,51	0,38	0,30	
		L/300	2,62	1,86	1,40	1,09	0,83	0,58	0,43	0,32	0,25	
0,60	5,16	*	3,57	2,52	1,88	1,46	1,17	0,95	0,80	0,67	0,58	
		L/200	3,57	2,52	1,88	1,46	1,17	0,95	0,79	0,59	0,46	
		L/250	3,57	2,52	1,88	1,46	1,17	0,87	0,63	0,48	0,37	
		L/300	3,57	2,52	1,88	1,46	1,03	0,72	0,53	0,40	0,31	
0,70	6,02	*	4,62	3,25	2,41	1,86	1,49	1,21	1,01	0,85	0,73	
		L/200	4,62	3,25	2,41	1,86	1,49	1,21	0,95	0,71	0,55	
		L/250	4,62	3,25	2,41	1,86	1,48	1,04	0,76	0,57	0,44	
		L/300	4,62	3,25	2,41	1,84	1,24	0,87	0,63	0,48	0,37	
0,75	6,46	*	5,18	3,63	2,69	2,08	1,65	1,35	1,12	0,95	0,81	
		L/200	5,18	3,63	2,69	2,08	1,65	1,35	1,03	0,77	0,59	
		L/250	5,18	3,63	2,69	2,08	1,61	1,13	0,82	0,62	0,48	
		L/300	5,18	3,63	2,69	2,00	1,34	0,94	0,69	0,51	0,40	
0,88	7,57	*	6,52	4,53	3,34	2,56	2,03	1,65	1,37	1,15	0,99	
		L/200	6,52	4,53	3,34	2,56	2,03	1,65	1,24	0,93	0,72	
		L/250	6,52	4,53	3,34	2,56	1,93	1,36	0,99	0,74	0,57	
		L/300	6,52	4,53	3,34	2,40	1,61	1,13	0,82	0,62	0,48	
1,00	8,61	*	7,73	5,34	3,92	3,00	2,37	1,92	1,59	1,33	1,14	
		L/200	7,73	5,34	3,92	3,00	2,37	1,92	1,43	1,07	0,83	
		L/250	7,73	5,34	3,92	3,00	2,24	1,57	1,14	0,86	0,66	
		L/300	7,73	5,34	3,92	2,78	1,86	1,31	0,95	0,72	0,55	
1,25	10,76	*	10,31	7,04	5,12	3,89	3,06	2,47	2,03	1,71	1,45	
		L/200	10,31	7,04	5,12	3,89	3,06	2,47	1,82	1,37	1,05	
		L/250	10,31	7,04	5,12	3,89	2,84	2,00	1,46	1,09	0,84	
		L/300	10,31	7,04	5,12	3,54	2,37	1,66	1,21	0,91	0,70	
1,50	12,91	*	12,89	8,73	6,31	4,78	3,74	3,01	2,47	2,07	1,76	
		L/200	12,89	8,73	6,31	4,78	3,74	2,99	2,18	1,64	1,26	
		L/250	12,89	8,73	6,31	4,78	3,40	2,39	1,74	1,31	1,01	
		L/300	12,89	8,73	6,31	4,23	2,84	1,99	1,45	1,09	0,84	

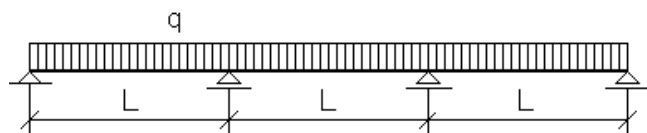

TRAPEZ T - 30 B,eff

Oceľ S 250 GD

<i>t</i>	<i>g</i>	Kritérium pre	Medzné zaťaženie <i>q</i> [kN/m ²] pre rozpätie <i>L</i> [m]									
			1,00	1,25	1,50	1,75	2,00	2,25	2,50	2,75	3,00	
[mm]	[kg/m ²]	* pevnosť δ_{max}										
0,40	3,44	*	1.97	1.43	1.09	0.86	0.70	0.58	0.49	0.42	0.36	
		L/200	1.97	1.43	1.09	0.86	0.70	0.53	0.39	0.29	0.23	
		L/250	1.97	1.43	1.09	0.86	0.61	0.43	0.31	0.23	0.18	
		L/300	1.97	1.43	1.09	0.76	0.51	0.36	0.26	0.19	0.15	
0,50	4,30	*	2.93	2.11	1.60	1.25	1.01	0.83	0.70	0.60	0.52	
		L/200	2.93	2.11	1.60	1.25	0.99	0.70	0.51	0.38	0.29	
		L/250	2.93	2.11	1.60	1.18	0.79	0.56	0.41	0.30	0.23	
		L/300	2.93	2.11	1.57	0.99	0.66	0.46	0.34	0.25	0.20	
0,60	5,16	*	4.02	2.87	2.16	1.69	1.36	1.12	0.94	0.80	0.69	
		L/200	4.02	2.87	2.16	1.69	1.23	0.86	0.63	0.47	0.36	
		L/250	4.02	2.87	2.16	1.47	0.98	0.69	0.50	0.38	0.29	
		L/300	4.02	2.87	1.94	1.22	0.82	0.58	0.42	0.31	0.24	
0,70	6,02	*	5.23	3.72	2.79	2.17	1.74	1.43	1.19	1.01	0.87	
		L/200	5.23	3.72	2.79	2.17	1.47	1.03	0.75	0.57	0.44	
		L/250	5.23	3.72	2.79	1.76	1.18	0.83	0.60	0.45	0.35	
		L/300	5.23	3.72	2.33	1.46	0.98	0.69	0.50	0.38	0.29	
0,75	6,46	*	5.88	4.17	3.12	2.43	1.94	1.59	1.33	1.13	0.97	
		L/200	5.88	4.17	3.12	2.38	1.59	1.12	0.82	0.61	0.47	
		L/250	5.88	4.17	3.02	1.90	1.28	0.90	0.65	0.49	0.38	
		L/300	5.88	4.17	2.52	1.59	1.06	0.75	0.54	0.41	0.31	
0,88	7,57	*	7.45	5.24	3.89	3.01	2.40	1.96	1.63	1.38	1.18	
		L/200	7.45	5.24	3.89	2.86	1.92	1.35	0.98	0.74	0.57	
		L/250	7.45	5.24	3.64	2.29	1.53	1.08	0.79	0.59	0.45	
		L/300	7.45	5.24	3.03	1.91	1.28	0.90	0.65	0.49	0.38	
1,00	8,61	*	8.90	6.22	4.60	3.54	2.81	2.29	1.90	1.60	1.37	
		L/200	8.90	6.22	4.60	3.31	2.22	1.56	1.14	0.85	0.66	
		L/250	8.90	6.22	4.21	2.65	1.77	1.25	0.91	0.68	0.53	
		L/300	8.90	6.06	3.51	2.21	1.48	1.04	0.76	0.57	0.44	
1,25	10,76	*	11.99	8.28	6.07	4.64	3.66	2.97	2.45	2.06	1.76	
		L/200	11.99	8.28	6.07	4.21	2.82	1.98	1.45	1.09	0.84	
		L/250	11.99	8.28	5.35	3.37	2.26	1.59	1.16	0.87	0.67	
		L/300	11.99	7.71	4.46	2.81	1.88	1.32	0.96	0.72	0.56	
1,50	12,91	*	15.13	10.35	7.53	5.73	4.51	3.64	3.00	2.52	2.14	
		L/200	15.13	10.35	7.53	5.04	3.38	2.37	1.73	1.30	1.00	
		L/250	15.13	10.35	6.41	4.03	2.70	1.90	1.38	1.04	0.80	
		L/300	15.13	9.22	5.34	3.36	2.25	1.58	1.15	0.87	0.67	

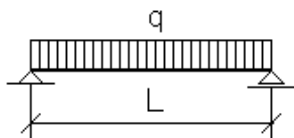

TRAPEZ T - 30 B,eff

Oceľ S 280 GD

t	g	Kritérium pre	Medzné zaťaženie q [kN/m^2] pre rozpätie L [m]									
			[mm]	[kg/m^2]	* pevnosť δ_{max}	1,00	1,25	1,50	1,75	2,00	2,25	2,50
0,40	3,44	*		2,77	2,22	1,85	1,58	1,38	1,23	1,11	0,95	0,80
		L/200	2,77	1,61	0,93	0,59	0,39	0,28	0,20	0,15	0,12	
		L/250	2,58	1,32	0,76	0,48	0,32	0,23	0,17	0,12	0,10	
		L/300	2,09	1,07	0,62	0,39	0,26	0,18	0,13	0,10	0,08	
0,50	4,30	*		4,28	3,43	2,86	2,45	2,14	1,90	1,59	1,31	1,10
		L/200	4,09	2,09	1,21	0,76	0,51	0,36	0,26	0,20	0,15	
		L/250	3,43	1,76	1,02	0,64	0,43	0,30	0,22	0,17	0,13	
		L/300	2,73	1,40	0,81	0,51	0,34	0,24	0,17	0,13	0,10	
0,60	5,16	*		6,12	4,90	4,08	3,50	3,06	2,56	2,07	1,71	1,44
		L/200	5,07	2,60	1,50	0,95	0,63	0,45	0,32	0,24	0,19	
		L/250	4,35	2,23	1,29	0,81	0,54	0,38	0,28	0,21	0,16	
		L/300	3,38	1,73	1,00	0,63	0,42	0,30	0,22	0,16	0,13	
0,70	6,02	*		8,28	6,62	5,52	4,73	4,06	3,21	2,60	2,15	1,80
		L/200	6,07	3,11	1,80	1,13	0,76	0,53	0,39	0,29	0,22	
		L/250	5,31	2,72	1,57	0,99	0,66	0,47	0,34	0,26	0,20	
		L/300	4,05	2,07	1,20	0,76	0,51	0,36	0,26	0,19	0,15	
0,75	6,46	*		9,49	7,59	6,32	5,42	4,49	3,55	2,88	2,38	2,00
		L/200	6,58	3,37	1,95	1,23	0,82	0,58	0,42	0,32	0,24	
		L/250	5,81	2,97	1,72	1,08	0,73	0,51	0,37	0,28	0,22	
		L/300	4,39	2,25	1,30	0,82	0,55	0,39	0,28	0,21	0,16	
0,88	7,57	*		13,03	10,43	8,69	7,43	5,69	4,50	3,64	3,01	2,53
		L/200	7,92	4,06	2,35	1,48	0,99	0,70	0,51	0,38	0,29	
		L/250	6,97	3,57	2,06	1,30	0,87	0,61	0,45	0,34	0,26	
		L/300	5,28	2,70	1,56	0,99	0,66	0,46	0,34	0,25	0,20	
1,00	8,61	*		16,85	13,48	11,23	8,97	6,87	5,43	4,40	3,63	3,05
		L/200	9,17	4,69	2,72	1,71	1,15	0,80	0,59	0,44	0,34	
		L/250	7,86	4,02	2,33	1,47	0,98	0,69	0,50	0,38	0,29	
		L/300	6,11	3,13	1,81	1,14	0,76	0,54	0,39	0,29	0,23	
1,25	10,76	*		26,66	21,33	16,80	12,34	9,45	7,46	6,05	5,00	4,20
		L/200	11,75	6,01	3,48	2,19	1,47	1,03	0,75	0,56	0,44	
		L/250	9,66	4,95	2,86	1,80	1,21	0,85	0,62	0,46	0,36	
		L/300	7,83	4,01	2,32	1,46	0,98	0,69	0,50	0,38	0,29	
1,50	12,91	*		39,30	29,46	20,46	15,03	11,51	9,09	7,37	6,09	5,12
		L/200	14,05	7,20	4,16	2,62	1,76	1,23	0,90	0,68	0,52	
		L/250	11,40	5,84	3,38	2,13	1,43	1,00	0,73	0,55	0,42	
		L/300	9,37	4,80	2,78	1,75	1,17	0,82	0,60	0,45	0,35	

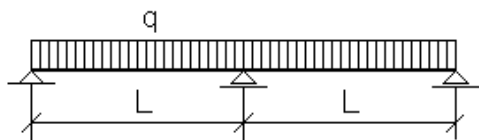

TRAPEZ T - 30 B,eff

Oceľ S 280 GD

t	g	Kritérium pre	Medzné zaťaženie q [kN/m^2] pre rozpätie L [m]									
			[mm]	[kg/m^2]	* pevnosť δ_{max}	1,00	1,25	1,50	1,75	2,00	2,25	2,50
0,40	3,44	*		1,91	1,37	1,04	0,82	0,66	0,54	0,46	0,39	0,34
		L/200		1,91	1,37	1,04	0,82	0,66	0,54	0,46	0,36	0,28
		L/250		1,91	1,37	1,04	0,82	0,66	0,53	0,39	0,29	0,22
		L/300		1,91	1,37	1,04	0,82	0,63	0,44	0,32	0,24	0,19
0,50	4,30	*		2,82	2,01	1,51	1,18	0,95	0,78	0,65	0,55	0,47
		L/200		2,82	2,01	1,51	1,18	0,95	0,78	0,63	0,47	0,37
		L/250		2,82	2,01	1,51	1,18	0,95	0,69	0,50	0,38	0,29
		L/300		2,82	2,01	1,51	1,18	0,82	0,58	0,42	0,32	0,24
0,60	5,16	*		3,85	2,72	2,03	1,58	1,26	1,03	0,86	0,73	0,63
		L/200		3,85	2,72	2,03	1,58	1,26	1,03	0,78	0,59	0,45
		L/250		3,85	2,72	2,03	1,58	1,22	0,86	0,63	0,47	0,36
		L/300		3,85	2,72	2,03	1,52	1,02	0,72	0,52	0,39	0,30
0,70	6,02	*		4,98	3,50	2,61	2,02	1,61	1,31	1,09	0,93	0,79
		L/200		4,98	3,50	2,61	2,02	1,61	1,29	0,94	0,70	0,54
		L/250		4,98	3,50	2,61	2,02	1,46	1,03	0,75	0,56	0,43
		L/300		4,98	3,50	2,61	1,82	1,22	0,86	0,62	0,47	0,36
0,75	6,46	*		5,59	3,92	2,91	2,25	1,79	1,46	1,22	1,03	0,88
		L/200		5,59	3,92	2,91	2,25	1,79	1,39	1,02	0,76	0,59
		L/250		5,59	3,92	2,91	2,25	1,59	1,11	0,81	0,61	0,47
		L/300		5,59	3,92	2,91	1,97	1,32	0,93	0,68	0,51	0,39
0,88	7,57	*		7,13	4,97	3,67	2,83	2,24	1,83	1,52	1,28	1,09
		L/200		7,13	4,97	3,67	2,83	2,24	1,68	1,22	0,92	0,71
		L/250		7,13	4,97	3,67	2,83	1,91	1,34	0,98	0,73	0,57
		L/300		7,13	4,97	3,67	2,38	1,59	1,12	0,81	0,61	0,47
1,00	8,61	*		8,48	5,87	4,32	3,31	2,62	2,12	1,76	1,48	1,26
		L/200		8,48	5,87	4,32	3,31	2,62	1,94	1,41	1,06	0,82
		L/250		8,48	5,87	4,32	3,30	2,21	1,55	1,13	0,85	0,65
		L/300		8,48	5,87	4,32	2,75	1,84	1,29	0,94	0,71	0,55
1,25	10,76	*		11,33	7,76	5,66	4,31	3,39	2,74	2,26	1,89	1,61
		L/200		11,33	7,76	5,66	4,31	3,39	2,49	1,81	1,36	1,05
		L/250		11,33	7,76	5,66	4,23	2,83	1,99	1,45	1,09	0,84
		L/300		11,33	7,76	5,60	3,52	2,36	1,66	1,21	0,91	0,70
1,50	12,91	*		14,21	9,65	6,99	5,30	4,15	3,34	2,75	2,30	1,96
		L/200		14,21	9,65	6,99	5,30	4,15	2,98	2,17	1,63	1,26
		L/250		14,21	9,65	6,99	5,06	3,39	2,38	1,74	1,30	1,00
		L/300		14,21	9,65	6,69	4,22	2,82	1,98	1,45	1,09	0,84

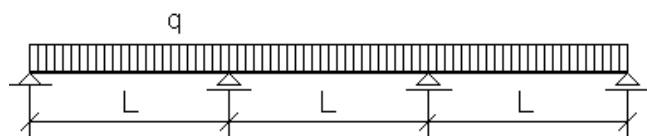

TRAPEZ T - 30 B,eff

Oceľ S 280 GD

t	g	Kritérium pre	Medzné zaťaženie q [kN/m^2] pre rozpätie L [m]									
			1,00	1,25	1,50	1,75	2,00	2,25	2,50	2,75	3,00	
[mm]	[kg/m^2]	* pevnosť δ_{max}										
0,40	3,44	*	2.11	1.54	1.17	0.93	0.76	0.63	0.53	0.45	0.39	
		L/200	2.11	1.54	1.17	0.93	0.75	0.53	0.38	0.29	0.22	
		L/250	2.11	1.54	1.17	0.90	0.60	0.42	0.31	0.23	0.18	
		L/300	2.11	1.54	1.17	0.75	0.50	0.35	0.26	0.19	0.15	
0,50	4,30	*	3.15	2.27	1.72	1.35	1.09	0.90	0.76	0.65	0.56	
		L/200	3.15	2.27	1.72	1.35	0.98	0.69	0.50	0.38	0.29	
		L/250	3.15	2.27	1.72	1.17	0.78	0.55	0.40	0.30	0.23	
		L/300	3.15	2.27	1.55	0.97	0.65	0.46	0.33	0.25	0.19	
0,60	5,16	*	4.32	3.10	2.33	1.83	1.47	1.21	1.01	0.86	0.74	
		L/200	4.32	3.10	2.33	1.81	1.21	0.85	0.62	0.47	0.36	
		L/250	4.32	3.10	2.30	1.45	0.97	0.68	0.50	0.37	0.29	
		L/300	4.32	3.10	1.92	1.21	0.81	0.57	0.41	0.31	0.24	
0,70	6,02	*	5.63	4.01	3.01	2.35	1.88	1.55	1.29	1.10	0.94	
		L/200	5.63	4.01	3.01	2.17	1.45	1.02	0.74	0.56	0.43	
		L/250	5.63	4.01	2.76	1.74	1.16	0.82	0.60	0.45	0.34	
		L/300	5.63	3.97	2.30	1.45	0.97	0.68	0.50	0.37	0.29	
0,75	6,46	*	6.33	4.49	3.37	2.62	2.10	1.72	1.44	1.22	1.05	
		L/200	6.33	4.49	3.37	2.35	1.58	1.11	0.81	0.61	0.47	
		L/250	6.33	4.49	2.99	1.88	1.26	0.89	0.65	0.48	0.37	
		L/300	6.33	4.30	2.49	1.57	1.05	0.74	0.54	0.40	0.31	
0,88	7,57	*	8.13	5.74	4.27	3.31	2.65	2.16	1.80	1.52	1.31	
		L/200	8.13	5.74	4.27	2.83	1.90	1.33	0.97	0.73	0.56	
		L/250	8.13	5.74	3.60	2.26	1.52	1.07	0.78	0.58	0.45	
		L/300	8.13	5.18	3.00	1.89	1.26	0.89	0.65	0.49	0.37	
1,00	8,61	*	9.74	6.82	5.05	3.90	3.10	2.53	2.10	1.77	1.52	
		L/200	9.74	6.82	5.05	3.28	2.19	1.54	1.12	0.84	0.65	
		L/250	9.74	6.82	4.16	2.62	1.76	1.23	0.90	0.68	0.52	
		L/300	9.74	5.99	3.47	2.18	1.46	1.03	0.75	0.56	0.43	
1,25	10,76	*	13.16	9.10	6.69	5.12	4.05	3.29	2.72	2.29	1.95	
		L/200	13.16	9.10	6.66	4.20	2.81	1.97	1.44	1.08	0.83	
		L/250	13.16	9.10	5.33	3.36	2.25	1.58	1.15	0.87	0.67	
		L/300	13.16	7.68	4.44	2.80	1.87	1.32	0.96	0.72	0.56	
1,50	12,91	*	16.63	11.41	8.32	6.34	4.99	4.03	3.33	2.79	2.38	
		L/200	16.63	11.41	7.97	5.02	3.36	2.36	1.72	1.29	1.00	
		L/250	16.63	11.02	6.38	4.02	2.69	1.89	1.38	1.04	0.80	
		L/300	16.63	9.19	5.32	3.35	2.24	1.58	1.15	0.86	0.66	

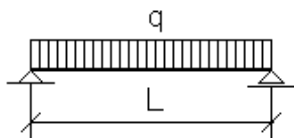

TRAPEZ T - 30 B,eff

Oceľ S 320 GD

<i>t</i>	<i>g</i>	Kritérium pre	Medzné zaťaženie q [kN/m^2] pre rozpätie L [m]									
			1,00	1,25	1,50	1,75	2,00	2,25	2,50	2,75	3,00	
[mm]	[kg/m^2]	* pevnosť δ_{max}										
0,40	3,44	*	2.96	2.37	1.97	1.69	1.48	1.32	1.18	1.06	0.89	
		L/200	2.96	1.58	0.92	0.58	0.39	0.27	0.20	0.15	0.11	
		L/250	2.53	1.30	0.75	0.47	0.32	0.22	0.16	0.12	0.09	
		L/300	2.06	1.06	0.61	0.39	0.26	0.18	0.13	0.10	0.08	
0,50	4,30	*	4.58	3.66	3.05	2.62	2.29	2.04	1.76	1.45	1.22	
		L/200	4.03	2.06	1.19	0.75	0.50	0.35	0.26	0.19	0.15	
		L/250	3.36	1.72	1.00	0.63	0.42	0.30	0.22	0.16	0.12	
		L/300	2.69	1.38	0.80	0.50	0.34	0.24	0.17	0.13	0.10	
0,60	5,16	*	6.54	5.23	4.36	3.74	3.27	2.82	2.29	1.89	1.59	
		L/200	5.00	2.56	1.48	0.93	0.62	0.44	0.32	0.24	0.19	
		L/250	4.25	2.18	1.26	0.79	0.53	0.37	0.27	0.20	0.16	
		L/300	3.33	1.71	0.99	0.62	0.42	0.29	0.21	0.16	0.12	
0,70	6,02	*	8.85	7.08	5.90	5.06	4.43	3.54	2.87	2.37	1.99	
		L/200	5.99	3.07	1.77	1.12	0.75	0.53	0.38	0.29	0.22	
		L/250	5.19	2.66	1.54	0.97	0.65	0.46	0.33	0.25	0.19	
		L/300	3.99	2.04	1.18	0.74	0.50	0.35	0.26	0.19	0.15	
0,75	6,46	*	10.14	8.11	6.76	5.80	4.96	3.92	3.17	2.62	2.20	
		L/200	6.49	3.32	1.92	1.21	0.81	0.57	0.42	0.31	0.24	
		L/250	5.68	2.91	1.68	1.06	0.71	0.50	0.36	0.27	0.21	
		L/300	4.33	2.22	1.28	0.81	0.54	0.38	0.28	0.21	0.16	
0,88	7,57	*	13.93	11.14	9.29	7.96	6.27	4.95	4.01	3.32	2.79	
		L/200	7.81	4.00	2.31	1.46	0.98	0.69	0.50	0.38	0.29	
		L/250	6.97	3.57	2.06	1.30	0.87	0.61	0.45	0.34	0.26	
		L/300	5.21	2.67	1.54	0.97	0.65	0.46	0.33	0.25	0.19	
1,00	8,61	*	18.02	14.41	12.01	9.88	7.57	5.98	4.84	4.00	3.36	
		L/200	9.04	4.63	2.68	1.69	1.13	0.79	0.58	0.43	0.33	
		L/250	7.86	4.02	2.33	1.47	0.98	0.69	0.50	0.38	0.29	
		L/300	6.03	3.09	1.79	1.13	0.75	0.53	0.39	0.29	0.22	
1,25	10,76	*	28.50	22.80	18.61	13.67	10.47	8.27	6.70	5.54	4.65	
		L/200	11.63	5.95	3.44	2.17	1.45	1.02	0.74	0.56	0.43	
		L/250	9.66	4.95	2.86	1.80	1.21	0.85	0.62	0.46	0.36	
		L/300	7.75	3.97	2.30	1.45	0.97	0.68	0.50	0.37	0.29	
1,50	12,91	*	42.02	33.19	23.05	16.93	12.96	10.24	8.30	6.86	5.76	
		L/200	13.99	7.16	4.14	2.61	1.75	1.23	0.90	0.67	0.52	
		L/250	11.40	5.84	3.38	2.13	1.43	1.00	0.73	0.55	0.42	
		L/300	9.32	4.77	2.76	1.74	1.17	0.82	0.60	0.45	0.35	

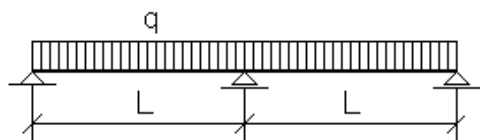

TRAPEZ T - 30 B,eff

Oceľ S 320 GD

<i>t</i>	<i>g</i>	Kritérium pre	Medzné zaťaženie <i>q</i> [kN/m ²] pre rozpätie <i>L</i> [m]									
			1,00	1,25	1,50	1,75	2,00	2,25	2,50	2,75	3,00	
[mm]	[kg/m ²]	* pevnosť δ_{max}										
0,40	3,44	*	2.08	1.50	1.14	0.89	0.72	0.60	0.50	0.43	0.37	
		L/200	2.08	1.50	1.14	0.89	0.72	0.60	0.48	0.36	0.28	
		L/250	2.08	1.50	1.14	0.89	0.72	0.52	0.38	0.29	0.22	
		L/300	2.08	1.50	1.14	0.89	0.62	0.44	0.32	0.24	0.18	
0,50	4,30	*	3.07	2.20	1.65	1.29	1.04	0.85	0.71	0.61	0.52	
		L/200	3.07	2.20	1.65	1.29	1.04	0.85	0.62	0.47	0.36	
		L/250	3.07	2.20	1.65	1.29	0.97	0.68	0.50	0.37	0.29	
		L/300	3.07	2.20	1.65	1.21	0.81	0.57	0.41	0.31	0.24	
0,60	5,16	*	4.20	2.98	2.23	1.73	1.39	1.14	0.95	0.80	0.69	
		L/200	4.20	2.98	2.23	1.73	1.39	1.06	0.77	0.58	0.45	
		L/250	4.20	2.98	2.23	1.73	1.21	0.85	0.62	0.46	0.36	
		L/300	4.20	2.98	2.23	1.50	1.00	0.71	0.51	0.39	0.30	
0,70	6,02	*	5.44	3.84	2.86	2.21	1.77	1.45	1.20	1.02	0.87	
		L/200	5.44	3.84	2.86	2.21	1.77	1.27	0.92	0.69	0.53	
		L/250	5.44	3.84	2.86	2.16	1.44	1.01	0.74	0.56	0.43	
		L/300	5.44	3.84	2.85	1.80	1.20	0.85	0.62	0.46	0.36	
0,75	6,46	*	6.10	4.29	3.19	2.47	1.97	1.61	1.34	1.13	0.97	
		L/200	6.10	4.29	3.19	2.47	1.96	1.37	1.00	0.75	0.58	
		L/250	6.10	4.29	3.19	2.34	1.57	1.10	0.80	0.60	0.46	
		L/300	6.10	4.29	3.09	1.95	1.30	0.92	0.67	0.50	0.39	
0,88	7,57	*	7.93	5.55	4.11	3.17	2.52	2.05	1.71	1.44	1.23	
		L/200	7.93	5.55	4.11	3.17	2.35	1.65	1.21	0.91	0.70	
		L/250	7.93	5.55	4.11	2.81	1.88	1.32	0.96	0.72	0.56	
		L/300	7.93	5.55	3.72	2.34	1.57	1.10	0.80	0.60	0.47	
1,00	8,61	*	9.44	6.56	4.84	3.71	2.94	2.39	1.98	1.67	1.43	
		L/200	9.44	6.56	4.84	3.71	2.73	1.91	1.40	1.05	0.81	
		L/250	9.44	6.56	4.84	3.26	2.18	1.53	1.12	0.84	0.65	
		L/300	9.44	6.56	4.31	2.71	1.82	1.28	0.93	0.70	0.54	
1,25	10,76	*	12.66	8.70	6.36	4.85	3.82	3.09	2.55	2.14	1.82	
		L/200	12.66	8.70	6.36	4.85	3.50	2.46	1.79	1.35	1.04	
		L/250	12.66	8.70	6.36	4.18	2.80	1.97	1.44	1.08	0.83	
		L/300	12.66	8.70	5.54	3.49	2.34	1.64	1.20	0.90	0.69	
1,50	12,91	*	15.92	10.85	7.87	5.97	4.69	3.78	3.11	2.61	2.22	
		L/200	15.92	10.85	7.87	5.97	4.22	2.96	2.16	1.62	1.25	
		L/250	15.92	10.85	7.87	5.03	3.37	2.37	1.73	1.30	1.00	
		L/300	15.92	10.85	6.66	4.20	2.81	1.97	1.44	1.08	0.83	

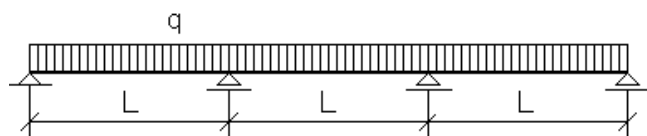

TRAPEZ T - 30 B,eff

Oceľ S 320 GD

t	g	Kritérium pre	Medzné zaťaženie q [kN/m^2] pre rozpätie L [m]									
			1,00	1,25	1,50	1,75	2,00	2,25	2,50	2,75	3,00	
[mm]	[kg/m^2]	* pevnosť δ_{max}										
0,40	3,44	*	2.30	1.68	1.28	1.02	0.83	0.69	0.58	0.50	0.43	
		L/200	2.30	1.68	1.28	1.02	0.74	0.52	0.38	0.28	0.22	
		L/250	2.30	1.68	1.28	0.88	0.59	0.42	0.30	0.23	0.18	
		L/300	2.30	1.68	1.17	0.74	0.49	0.35	0.25	0.19	0.15	
0,50	4,30	*	3.43	2.48	1.88	1.48	1.20	0.99	0.83	0.71	0.62	
		L/200	3.43	2.48	1.88	1.44	0.96	0.68	0.49	0.37	0.29	
		L/250	3.43	2.48	1.83	1.15	0.77	0.54	0.40	0.30	0.23	
		L/300	3.43	2.48	1.52	0.96	0.64	0.45	0.33	0.25	0.19	
0,60	5,16	*	4.71	3.38	2.55	2.00	1.61	1.33	1.11	0.95	0.82	
		L/200	4.71	3.38	2.55	1.79	1.20	0.84	0.61	0.46	0.35	
		L/250	4.71	3.38	2.27	1.43	0.96	0.67	0.49	0.37	0.28	
		L/300	4.71	3.27	1.89	1.19	0.80	0.56	0.41	0.31	0.24	
0,70	6,02	*	6.13	4.38	3.29	2.57	2.07	1.70	1.42	1.21	1.04	
		L/200	6.13	4.38	3.29	2.14	1.43	1.01	0.73	0.55	0.42	
		L/250	6.13	4.38	2.72	1.71	1.15	0.81	0.59	0.44	0.34	
		L/300	6.13	3.91	2.27	1.43	0.96	0.67	0.49	0.37	0.28	
0,75	6,46	*	6.90	4.91	3.68	2.87	2.30	1.89	1.58	1.34	1.15	
		L/200	6.90	4.91	3.68	2.32	1.55	1.09	0.80	0.60	0.46	
		L/250	6.90	4.91	2.95	1.86	1.24	0.87	0.64	0.48	0.37	
		L/300	6.90	4.24	2.46	1.55	1.04	0.73	0.53	0.40	0.31	
0,88	7,57	*	9.01	6.38	4.77	3.70	2.96	2.43	2.02	1.71	1.47	
		L/200	9.01	6.38	4.43	2.79	1.87	1.31	0.96	0.72	0.55	
		L/250	9.01	6.13	3.55	2.23	1.50	1.05	0.77	0.58	0.44	
		L/300	9.01	5.11	2.95	1.86	1.25	0.88	0.64	0.48	0.37	
1,00	8,61	*	10.80	7.59	5.64	4.36	3.48	2.84	2.36	2.00	1.71	
		L/200	10.80	7.59	5.13	3.23	2.16	1.52	1.11	0.83	0.64	
		L/250	10.80	7.09	4.11	2.59	1.73	1.22	0.89	0.67	0.51	
		L/300	10.80	5.91	3.42	2.15	1.44	1.01	0.74	0.56	0.43	
1,25	10,76	*	14.65	10.18	7.49	5.75	4.56	3.70	3.07	2.58	2.20	
		L/200	14.65	10.18	6.60	4.15	2.78	1.95	1.42	1.07	0.82	
		L/250	14.65	9.12	5.28	3.32	2.23	1.56	1.14	0.86	0.66	
		L/300	14.65	7.60	4.40	2.77	1.86	1.30	0.95	0.71	0.55	
1,50	12,91	*	18.58	12.78	9.35	7.14	5.63	4.55	3.76	3.16	2.69	
		L/200	18.58	12.78	7.94	5.00	3.35	2.35	1.71	1.29	0.99	
		L/250	18.58	10.97	6.35	4.00	2.68	1.88	1.37	1.03	0.79	
		L/300	17.85	9.14	5.29	3.33	2.23	1.57	1.14	0.86	0.66	

3.3 STEPPO-A,eff

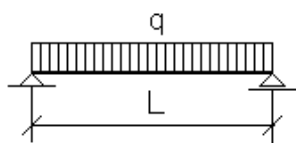

STEPPO A,eff

Oceľ S 220 GD

t	g	Kritérium pre	Medzné zaťaženie q [kN/m^2] pre rozpätie L [m]							
			δ_{max}	0,75	1,00	1,25	1,50	1,75	2,00	2,25
0,40	3,44	*	2.59	1.46	0.93	0.65	0.48	0.36	0.29	0.23
		$L/200$	1.25	0.53	0.27	0.16	0.10	0.07	0.05	0.03
		$L/250$	1.00	0.42	0.22	0.12	0.08	0.05	0.04	0.03
		$L/300$	0.83	0.35	0.18	0.10	0.07	0.04	0.03	0.02
0,50	4,30	*	3.58	2.02	1.29	0.90	0.66	0.50	0.40	0.32
		$L/200$	1.65	0.69	0.36	0.21	0.13	0.09	0.06	0.04
		$L/250$	1.32	0.56	0.28	0.16	0.10	0.07	0.05	0.04
		$L/300$	1.10	0.46	0.24	0.14	0.09	0.06	0.04	0.03
0,60	5,16	*	4.69	2.64	1.69	1.17	0.86	0.66	0.52	0.42
		$L/200$	2.07	0.87	0.45	0.26	0.16	0.11	0.08	0.06
		$L/250$	1.66	0.70	0.36	0.21	0.13	0.09	0.06	0.04
		$L/300$	1.38	0.58	0.30	0.17	0.11	0.07	0.05	0.04
0,70	6,02	*	5.89	3.31	2.12	1.47	1.08	0.83	0.65	0.53
		$L/200$	2.51	1.06	0.54	0.31	0.20	0.13	0.09	0.07
		$L/250$	2.00	0.85	0.43	0.25	0.16	0.11	0.07	0.05
		$L/300$	1.67	0.70	0.36	0.21	0.13	0.09	0.06	0.05
0,75	6,46	*	6.53	3.67	2.35	1.63	1.20	0.92	0.73	0.59
		$L/200$	2.73	1.15	0.59	0.34	0.21	0.14	0.10	0.07
		$L/250$	2.18	0.92	0.47	0.27	0.17	0.12	0.08	0.06
		$L/300$	1.82	0.77	0.39	0.23	0.14	0.10	0.07	0.05
0,88	7,57	*	8.28	4.66	2.98	2.07	1.52	1.16	0.92	0.74
		$L/200$	3.31	1.40	0.72	0.41	0.26	0.17	0.12	0.09
		$L/250$	2.65	1.12	0.57	0.33	0.21	0.14	0.10	0.07
		$L/300$	2.21	0.93	0.48	0.28	0.17	0.12	0.08	0.06
1,00	8,61	*	10.00	5.62	3.60	2.50	1.84	1.41	1.11	0.90
		$L/200$	3.86	1.63	0.83	0.48	0.30	0.20	0.14	0.10
		$L/250$	3.09	1.30	0.67	0.39	0.24	0.16	0.11	0.08
		$L/300$	2.57	1.09	0.56	0.32	0.20	0.14	0.10	0.07
1,25	10,76	*	13.83	7.78	4.98	3.46	2.54	1.95	1.54	1.25
		$L/200$	5.01	2.11	1.08	0.63	0.39	0.26	0.19	0.14
		$L/250$	4.01	1.69	0.87	0.50	0.32	0.21	0.15	0.11
		$L/300$	3.34	1.41	0.72	0.42	0.26	0.18	0.12	0.09
1,50	12,91	*	17.89	10.06	6.44	4.47	3.29	2.52	1.99	1.61
		$L/200$	6.13	2.59	1.32	0.77	0.48	0.32	0.23	0.17
		$L/250$	4.91	2.07	1.06	0.61	0.39	0.26	0.18	0.13
		$L/300$	4.09	1.73	0.88	0.51	0.32	0.22	0.15	0.11

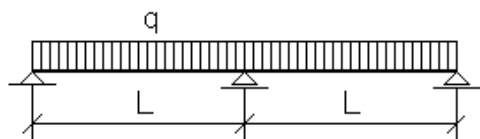

STEPRO A,eff

Oceľ S 220 GD

t	g	Kritérium pre	Medzné zaťaženie q [kN/m^2] pre rozpätie L [m]							
[mm]	[kg/m^2]	* pevnosť δ_{max}	0,75	1,00	1,25	1,50	1,75	2,00	2,25	2,50
0,40	3,44	*	1.94	1.24	0.86	0.64	0.49	0.39	0.32	0.26
		L/200	1.94	1.24	0.65	0.38	0.24	0.16	0.11	0.08
		L/250	1.94	1.01	0.52	0.30	0.19	0.13	0.09	0.06
		L/300	1.94	0.84	0.43	0.25	0.16	0.11	0.07	0.05
0,50	4,30	*	2.69	1.69	1.16	0.85	0.65	0.51	0.41	0.34
		L/200	2.69	1.68	0.86	0.50	0.31	0.21	0.15	0.11
		L/250	2.69	1.34	0.69	0.40	0.25	0.17	0.12	0.09
		L/300	2.65	1.12	0.57	0.33	0.21	0.14	0.10	0.07
0,60	5,16	*	3.46	2.14	1.46	1.06	0.80	0.63	0.51	0.42
		L/200	3.46	2.10	1.08	0.62	0.39	0.26	0.18	0.13
		L/250	3.46	1.68	0.86	0.50	0.31	0.21	0.15	0.11
		L/300	3.33	1.40	0.72	0.42	0.26	0.18	0.12	0.09
0,70	6,02	*	4.23	2.59	1.75	1.26	0.95	0.75	0.60	0.49
		L/200	4.23	2.55	1.30	0.76	0.48	0.32	0.22	0.16
		L/250	4.23	2.04	1.04	0.60	0.38	0.25	0.18	0.13
		L/300	4.03	1.70	0.87	0.50	0.32	0.21	0.15	0.11
0,75	6,46	*	4.61	2.81	1.90	1.36	1.03	0.80	0.65	0.53
		L/200	4.61	2.77	1.42	0.82	0.52	0.35	0.24	0.18
		L/250	4.61	2.22	1.14	0.66	0.41	0.28	0.19	0.14
		L/300	4.38	1.85	0.95	0.55	0.35	0.23	0.16	0.12
0,88	7,57	*	5.61	3.39	2.27	1.63	1.22	0.95	0.76	0.62
		L/200	5.61	3.37	1.73	1.00	0.63	0.42	0.30	0.22
		L/250	5.61	2.70	1.38	0.80	0.50	0.34	0.24	0.17
		L/300	5.33	2.25	1.15	0.67	0.42	0.28	0.20	0.14
1,00	8,61	*	6.53	3.91	2.61	1.86	1.40	1.09	0.87	0.71
		L/200	6.53	3.91	2.01	1.16	0.73	0.49	0.34	0.25
		L/250	6.53	3.14	1.61	0.93	0.59	0.39	0.28	0.20
		L/300	6.21	2.62	1.34	0.78	0.49	0.33	0.23	0.17
1,25	10,76	*	8.38	4.97	3.29	2.34	1.74	1.35	1.08	0.88
		L/200	8.38	4.97	2.61	1.51	0.95	0.64	0.45	0.33
		L/250	8.38	4.07	2.09	1.21	0.76	0.51	0.36	0.26
		L/300	8.05	3.40	1.74	1.01	0.63	0.42	0.30	0.22
1,50	12,91	*	10.17	5.98	3.94	2.79	2.08	1.61	1.28	1.04
		L/200	10.17	5.98	3.19	1.85	1.16	0.78	0.55	0.40
		L/250	10.17	4.99	2.56	1.48	0.93	0.62	0.44	0.32
		L/300	9.86	4.16	2.13	1.23	0.78	0.52	0.37	0.27

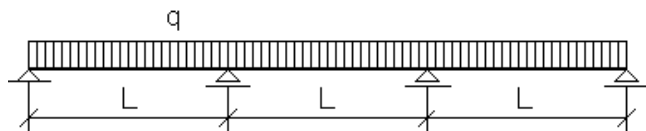

STEPRO A,eff

Oceľ S 220 GD

t	g	Kritérium pre	Medzné zaťaženie q [kN/m^2] pre rozpätie L [m]							
[mm]	[kg/m^2]	* pevnosť δ_{max}	0,75	1,00	1,25	1,50	1,75	2,00	2,25	2,50
0,40	3,44	*	2.18	1.41	1.00	0.74	0.57	0.46	0.37	0.31
		L/200	2.18	1.01	0.52	0.30	0.19	0.13	0.09	0.06
		L/250	1.91	0.80	0.41	0.24	0.15	0.10	0.07	0.05
		L/300	1.59	0.67	0.34	0.20	0.13	0.08	0.06	0.04
0,50	4,30	*	3.07	1.95	1.36	1.00	0.77	0.61	0.49	0.41
		L/200	3.07	1.33	0.68	0.39	0.25	0.17	0.12	0.09
		L/250	2.52	1.06	0.55	0.32	0.20	0.13	0.09	0.07
		L/300	2.10	0.89	0.45	0.26	0.17	0.11	0.08	0.06
0,60	5,16	*	3.98	2.50	1.72	1.26	0.96	0.76	0.61	0.50
		L/200	3.96	1.67	0.86	0.50	0.31	0.21	0.15	0.11
		L/250	3.17	1.34	0.68	0.40	0.25	0.17	0.12	0.09
		L/300	2.64	1.11	0.57	0.33	0.21	0.14	0.10	0.07
0,70	6,02	*	4.91	3.05	2.08	1.51	1.15	0.90	0.73	0.60
		L/200	4.80	2.02	1.04	0.60	0.38	0.25	0.18	0.13
		L/250	3.84	1.62	0.83	0.48	0.30	0.20	0.14	0.10
		L/300	3.20	1.35	0.69	0.40	0.25	0.17	0.12	0.09
0,75	6,46	*	5.38	3.32	2.26	1.64	1.24	0.97	0.78	0.64
		L/200	5.22	2.20	1.13	0.65	0.41	0.28	0.19	0.14
		L/250	4.18	1.76	0.90	0.52	0.33	0.22	0.15	0.11
		L/300	3.48	1.47	0.75	0.44	0.27	0.18	0.13	0.09
0,88	7,57	*	6.59	4.03	2.72	1.96	1.48	1.16	0.93	0.76
		L/200	6.35	2.68	1.37	0.79	0.50	0.33	0.24	0.17
		L/250	5.08	2.14	1.10	0.63	0.40	0.27	0.19	0.14
		L/300	4.23	1.78	0.91	0.53	0.33	0.22	0.16	0.11
1,00	8,61	*	7.71	4.67	3.14	2.25	1.70	1.32	1.06	0.87
		L/200	7.40	3.12	1.60	0.92	0.58	0.39	0.27	0.20
		L/250	5.92	2.50	1.28	0.74	0.47	0.31	0.22	0.16
		L/300	4.93	2.08	1.06	0.62	0.39	0.26	0.18	0.13
1,25	10,76	*	10.00	5.99	3.99	2.84	2.13	1.66	1.32	1.08
		L/200	9.59	4.04	2.07	1.20	0.75	0.51	0.36	0.26
		L/250	7.67	3.24	1.66	0.96	0.60	0.40	0.28	0.21
		L/300	6.39	2.70	1.38	0.80	0.50	0.34	0.24	0.17
1,50	12,91	*	12.21	7.25	4.80	3.41	2.55	1.97	1.58	1.29
		L/200	11.75	4.95	2.54	1.47	0.92	0.62	0.44	0.32
		L/250	9.40	3.96	2.03	1.17	0.74	0.50	0.35	0.25
		L/300	7.83	3.30	1.69	0.98	0.62	0.41	0.29	0.21

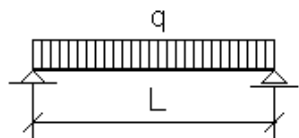

STEPRO A,eff

Oceľ S 250 GD

t	g	Kritérium pre	Medzné zaťaženie q [kN/m^2] pre rozpätie L [m]							
[mm]	[kg/m^2]	* pevnosť δ_{max}	0,75	1,00	1,25	1,50	1,75	2,00	2,25	2,50
0,40	3,44	*	2.86	1.61	1.03	0.71	0.53	0.40	0.32	0.26
		L/200	1.22	0.52	0.26	0.15	0.10	0.06	0.05	0.03
		L/250	0.98	0.41	0.21	0.12	0.08	0.05	0.04	0.03
		L/300	0.81	0.34	0.18	0.10	0.06	0.04	0.03	0.02
0,50	4,30	*	3.94	2.22	1.42	0.98	0.72	0.55	0.44	0.35
		L/200	1.61	0.68	0.35	0.20	0.13	0.09	0.06	0.04
		L/250	1.29	0.54	0.28	0.16	0.10	0.07	0.05	0.03
		L/300	1.08	0.45	0.23	0.13	0.08	0.06	0.04	0.03
0,60	5,16	*	5.14	2.89	1.85	1.29	0.94	0.72	0.57	0.46
		L/200	2.03	0.86	0.44	0.25	0.16	0.11	0.08	0.05
		L/250	1.62	0.68	0.35	0.20	0.13	0.09	0.06	0.04
		L/300	1.35	0.57	0.29	0.17	0.11	0.07	0.05	0.04
0,70	6,02	*	6.45	3.63	2.32	1.61	1.18	0.91	0.72	0.58
		L/200	2.45	1.04	0.53	0.31	0.19	0.13	0.09	0.07
		L/250	1.96	0.83	0.42	0.25	0.15	0.10	0.07	0.05
		L/300	1.64	0.69	0.35	0.20	0.13	0.09	0.06	0.04
0,75	6,46	*	7.14	4.02	2.57	1.79	1.31	1.00	0.79	0.64
		L/200	2.67	1.13	0.58	0.33	0.21	0.14	0.10	0.07
		L/250	2.14	0.90	0.46	0.27	0.17	0.11	0.08	0.06
		L/300	1.78	0.75	0.38	0.22	0.14	0.09	0.07	0.05
0,88	7,57	*	9.05	5.09	3.26	2.26	1.66	1.27	1.01	0.81
		L/200	3.25	1.37	0.70	0.41	0.26	0.17	0.12	0.09
		L/250	2.60	1.10	0.56	0.32	0.20	0.14	0.10	0.07
		L/300	2.16	0.91	0.47	0.27	0.17	0.11	0.08	0.06
1,00	8,61	*	10.92	6.14	3.93	2.73	2.01	1.54	1.21	0.98
		L/200	3.78	1.60	0.82	0.47	0.30	0.20	0.14	0.10
		L/250	3.03	1.28	0.65	0.38	0.24	0.16	0.11	0.08
		L/300	2.52	1.06	0.54	0.32	0.20	0.13	0.09	0.07
1,25	10,76	*	15.10	8.49	5.44	3.78	2.77	2.12	1.68	1.36
		L/200	4.91	2.07	1.06	0.61	0.39	0.26	0.18	0.13
		L/250	3.93	1.66	0.85	0.49	0.31	0.21	0.15	0.11
		L/300	3.27	1.38	0.71	0.41	0.26	0.17	0.12	0.09
1,50	12,91	*	19.53	10.98	7.03	4.88	3.59	2.75	2.17	1.76
		L/200	6.02	2.54	1.30	0.75	0.47	0.32	0.22	0.16
		L/250	4.82	2.03	1.04	0.60	0.38	0.25	0.18	0.13
		L/300	4.01	1.69	0.87	0.50	0.32	0.21	0.15	0.11

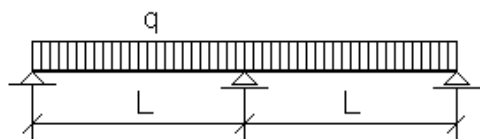

STEPRO A,eff

Oceľ S 250 GD

<i>t</i>	<i>g</i>	Kritérium pre	Medzné zaťaženie q [kN/m ²] pre rozpätie L [m]							
[mm]	[kg/m ²]	* pevnosť δ_{max}	0,75	1,00	1,25	1,50	1,75	2,00	2,25	2,50
0,40	3,44	*	2.14	1.37	0.96	0.71	0.55	0.43	0.35	0.29
		L/200	2.14	1.24	0.64	0.37	0.23	0.16	0.11	0.08
		L/250	2.14	0.99	0.51	0.29	0.19	0.12	0.09	0.06
		L/300	1.96	0.83	0.42	0.25	0.15	0.10	0.07	0.05
0,50	4,30	*	2.98	1.88	1.29	0.95	0.72	0.57	0.46	0.38
		L/200	2.98	1.64	0.84	0.49	0.31	0.21	0.14	0.11
		L/250	2.98	1.31	0.67	0.39	0.25	0.16	0.12	0.08
		L/300	2.60	1.09	0.56	0.32	0.20	0.14	0.10	0.07
0,60	5,16	*	3.84	2.38	1.63	1.18	0.90	0.71	0.57	0.47
		L/200	3.84	2.06	1.06	0.61	0.38	0.26	0.18	0.13
		L/250	3.84	1.65	0.84	0.49	0.31	0.21	0.14	0.11
		L/300	3.26	1.37	0.70	0.41	0.26	0.17	0.12	0.09
0,70	6,02	*	4.70	2.89	1.96	1.42	1.07	0.84	0.68	0.56
		L/200	4.70	2.50	1.28	0.74	0.47	0.31	0.22	0.16
		L/250	4.70	2.00	1.02	0.59	0.37	0.25	0.18	0.13
		L/300	3.94	1.66	0.85	0.49	0.31	0.21	0.15	0.11
0,75	6,46	*	5.14	3.14	2.12	1.53	1.16	0.91	0.73	0.60
		L/200	5.14	2.72	1.39	0.81	0.51	0.34	0.24	0.17
		L/250	5.14	2.17	1.11	0.64	0.41	0.27	0.19	0.14
		L/300	4.29	1.81	0.93	0.54	0.34	0.23	0.16	0.12
0,88	7,57	*	6.27	3.80	2.55	1.83	1.38	1.07	0.86	0.71
		L/200	6.27	3.30	1.69	0.98	0.62	0.41	0.29	0.21
		L/250	6.26	2.64	1.35	0.78	0.49	0.33	0.23	0.17
		L/300	5.22	2.20	1.13	0.65	0.41	0.28	0.19	0.14
1,00	8,61	*	7.30	4.39	2.93	2.10	1.57	1.22	0.98	0.80
		L/200	7.30	3.85	1.97	1.14	0.72	0.48	0.34	0.25
		L/250	7.30	3.08	1.58	0.91	0.57	0.38	0.27	0.20
		L/300	6.08	2.57	1.31	0.76	0.48	0.32	0.23	0.16
1,25	10,76	*	9.40	5.59	3.70	2.63	1.97	1.53	1.22	1.00
		L/200	9.40	4.99	2.56	1.48	0.93	0.62	0.44	0.32
		L/250	9.40	4.00	2.05	1.18	0.75	0.50	0.35	0.26
		L/300	7.89	3.33	1.70	0.99	0.62	0.42	0.29	0.21
1,50	12,91	*	11.43	6.74	4.44	3.15	2.35	1.82	1.45	1.18
		L/200	11.43	6.12	3.14	1.81	1.14	0.77	0.54	0.39
		L/250	11.43	4.90	2.51	1.45	0.91	0.61	0.43	0.31
		L/300	9.68	4.08	2.09	1.21	0.76	0.51	0.36	0.26

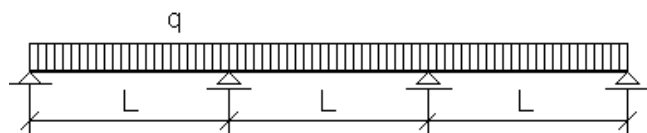

STEPRO A,eff

Oceľ S 250 GD

t	g	Kritérium pre	Medzné zaťaženie q [kN/m^2] pre rozpätie L [m]							
[mm]	[kg/m^2]	* pevnosť δ_{max}	0,75	1,00	1,25	1,50	1,75	2,00	2,25	2,50
0,40	3,44	*	2.40	1.56	1.10	0.82	0.64	0.51	0.42	0.35
		L/200	2.34	0.99	0.51	0.29	0.18	0.12	0.09	0.06
		L/250	1.87	0.79	0.40	0.23	0.15	0.10	0.07	0.05
		L/300	1.56	0.66	0.34	0.19	0.12	0.08	0.06	0.04
0,50	4,30	*	3.38	2.16	1.51	1.11	0.86	0.68	0.55	0.46
		L/200	3.09	1.30	0.67	0.39	0.24	0.16	0.11	0.08
		L/250	2.47	1.04	0.53	0.31	0.19	0.13	0.09	0.07
		L/300	2.06	0.87	0.45	0.26	0.16	0.11	0.08	0.06
0,60	5,16	*	4.41	2.78	1.91	1.40	1.07	0.85	0.69	0.57
		L/200	3.88	1.64	0.84	0.49	0.31	0.20	0.14	0.10
		L/250	3.11	1.31	0.67	0.39	0.24	0.16	0.12	0.08
		L/300	2.59	1.09	0.56	0.32	0.20	0.14	0.10	0.07
0,70	6,02	*	5.45	3.39	2.32	1.69	1.29	1.01	0.82	0.67
		L/200	4.70	1.98	1.01	0.59	0.37	0.25	0.17	0.13
		L/250	3.76	1.59	0.81	0.47	0.30	0.20	0.14	0.10
		L/300	3.13	1.32	0.68	0.39	0.25	0.17	0.12	0.08
0,75	6,46	*	5.97	3.70	2.52	1.83	1.39	1.09	0.88	0.73
		L/200	5.12	2.16	1.10	0.64	0.40	0.27	0.19	0.14
		L/250	4.09	1.73	0.88	0.51	0.32	0.22	0.15	0.11
		L/300	3.41	1.44	0.74	0.43	0.27	0.18	0.13	0.09
0,88	7,57	*	7.34	4.50	3.05	2.20	1.66	1.30	1.05	0.86
		L/200	6.22	2.62	1.34	0.78	0.49	0.33	0.23	0.17
		L/250	4.97	2.10	1.07	0.62	0.39	0.26	0.18	0.13
		L/300	4.14	1.75	0.90	0.52	0.33	0.22	0.15	0.11
1,00	8,61	*	8.60	5.23	3.52	2.53	1.91	1.49	1.20	0.98
		L/200	7.25	3.06	1.57	0.91	0.57	0.38	0.27	0.20
		L/250	5.80	2.45	1.25	0.72	0.46	0.31	0.21	0.16
		L/300	4.83	2.04	1.04	0.60	0.38	0.25	0.18	0.13
1,25	10,76	*	11.18	6.72	4.48	3.20	2.40	1.87	1.50	1.22
		L/200	9.40	3.97	2.03	1.18	0.74	0.50	0.35	0.25
		L/250	7.52	3.17	1.62	0.94	0.59	0.40	0.28	0.20
		L/300	6.27	2.64	1.35	0.78	0.49	0.33	0.23	0.17
1,50	12,91	*	13.69	8.15	5.40	3.84	2.87	2.23	1.78	1.45
		L/200	11.53	4.86	2.49	1.44	0.91	0.61	0.43	0.31
		L/250	9.22	3.89	1.99	1.15	0.73	0.49	0.34	0.25
		L/300	7.69	3.24	1.66	0.96	0.61	0.41	0.28	0.21

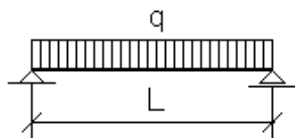

STEPRO A,eff

Oceľ S 280 GD

t	g	Kritérium pre	Medzné zaťaženie q [kN/m ²] pre rozpätie L [m]							
[mm]	[kg/m ²]	* pevnosť δ_{max}	0,75	1,00	1,25	1,50	1,75	2,00	2,25	2,50
0,40	3,44	*	3.12	1.75	1.12	0.78	0.57	0.44	0.35	0.28
		L/200	1.20	0.51	0.26	0.15	0.09	0.06	0.04	0.03
		L/250	0.96	0.41	0.21	0.12	0.08	0.05	0.04	0.03
		L/300	0.80	0.34	0.17	0.10	0.06	0.04	0.03	0.02
0,50	4,30	*	4.29	2.41	1.54	1.07	0.79	0.60	0.48	0.39
		L/200	1.59	0.67	0.34	0.20	0.12	0.08	0.06	0.04
		L/250	1.27	0.54	0.27	0.16	0.10	0.07	0.05	0.03
		L/300	1.06	0.45	0.23	0.13	0.08	0.06	0.04	0.03
0,60	5,16	*	5.58	3.14	2.01	1.40	1.03	0.79	0.62	0.50
		L/200	1.99	0.84	0.43	0.25	0.16	0.10	0.07	0.05
		L/250	1.59	0.67	0.34	0.20	0.13	0.08	0.06	0.04
		L/300	1.33	0.56	0.29	0.17	0.10	0.07	0.05	0.04
0,70	6,02	*	7.00	3.94	2.52	1.75	1.29	0.98	0.78	0.63
		L/200	2.41	1.02	0.52	0.30	0.19	0.13	0.09	0.07
		L/250	1.93	0.81	0.42	0.24	0.15	0.10	0.07	0.05
		L/300	1.61	0.68	0.35	0.20	0.13	0.08	0.06	0.04
0,75	6,46	*	7.74	4.36	2.79	1.94	1.42	1.09	0.86	0.70
		L/200	2.62	1.11	0.57	0.33	0.21	0.14	0.10	0.07
		L/250	2.10	0.89	0.45	0.26	0.17	0.11	0.08	0.06
		L/300	1.75	0.74	0.38	0.22	0.14	0.09	0.06	0.05
0,88	7,57	*	9.80	5.51	3.53	2.45	1.80	1.38	1.09	0.88
		L/200	3.19	1.34	0.69	0.40	0.25	0.17	0.12	0.09
		L/250	2.55	1.08	0.55	0.32	0.20	0.13	0.09	0.07
		L/300	2.12	0.90	0.46	0.27	0.17	0.11	0.08	0.06
1,00	8,61	*	11.81	6.65	4.25	2.95	2.17	1.66	1.31	1.06
		L/200	3.72	1.57	0.80	0.46	0.29	0.20	0.14	0.10
		L/250	2.97	1.25	0.64	0.37	0.23	0.16	0.11	0.08
		L/300	2.48	1.05	0.54	0.31	0.20	0.13	0.09	0.07
1,25	10,76	*	16.32	9.18	5.88	4.08	3.00	2.30	1.81	1.47
		L/200	4.82	2.04	1.04	0.60	0.38	0.25	0.18	0.13
		L/250	3.86	1.63	0.83	0.48	0.30	0.20	0.14	0.10
		L/300	3.22	1.36	0.69	0.40	0.25	0.17	0.12	0.09
1,50	12,91	*	21.11	11.87	7.60	5.28	3.88	2.97	2.35	1.90
		L/200	5.92	2.50	1.28	0.74	0.47	0.31	0.22	0.16
		L/250	4.74	2.00	1.02	0.59	0.37	0.25	0.18	0.13
		L/300	3.95	1.67	0.85	0.49	0.31	0.21	0.15	0.11

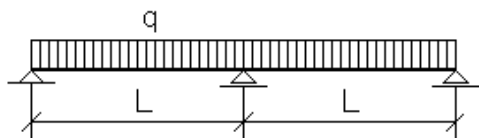

STEPRO A,eff

Oceľ S 280 GD

t	g	Kritérium pre	Medzné zaťaženie q [kN/m^2] pre rozpätie L [m]							
[mm]	[kg/m^2]	* pevnosť δ_{max}	0,75	1,00	1,25	1,50	1,75	2,00	2,25	2,50
0,40	3,44	*	2.32	1.49	1.05	0.78	0.60	0.48	0.39	0.32
		L/200	2.32	1.22	0.63	0.36	0.23	0.15	0.11	0.08
		L/250	2.32	0.98	0.50	0.29	0.18	0.12	0.09	0.06
		L/300	1.93	0.81	0.42	0.24	0.15	0.10	0.07	0.05
0,50	4,30	*	3.25	2.06	1.42	1.04	0.80	0.63	0.51	0.42
		L/200	3.25	1.61	0.83	0.48	0.30	0.20	0.14	0.10
		L/250	3.06	1.29	0.66	0.38	0.24	0.16	0.11	0.08
		L/300	2.55	1.08	0.55	0.32	0.20	0.13	0.09	0.07
0,60	5,16	*	4.20	2.62	1.79	1.31	0.99	0.78	0.63	0.52
		L/200	4.20	2.02	1.04	0.60	0.38	0.25	0.18	0.13
		L/250	3.84	1.62	0.83	0.48	0.30	0.20	0.14	0.10
		L/300	3.20	1.35	0.69	0.40	0.25	0.17	0.12	0.09
0,70	6,02	*	5.17	3.19	2.17	1.57	1.19	0.93	0.75	0.62
		L/200	5.17	2.45	1.25	0.73	0.46	0.31	0.22	0.16
		L/250	4.65	1.96	1.00	0.58	0.37	0.25	0.17	0.13
		L/300	3.87	1.63	0.84	0.48	0.30	0.20	0.14	0.10
0,75	6,46	*	5.65	3.47	2.35	1.70	1.28	1.01	0.81	0.66
		L/200	5.65	2.67	1.37	0.79	0.50	0.33	0.23	0.17
		L/250	5.06	2.13	1.09	0.63	0.40	0.27	0.19	0.14
		L/300	4.22	1.78	0.91	0.53	0.33	0.22	0.16	0.11
0,88	7,57	*	6.90	4.20	2.82	2.03	1.53	1.19	0.96	0.79
		L/200	6.90	3.24	1.66	0.96	0.60	0.41	0.28	0.21
		L/250	6.15	2.59	1.33	0.77	0.48	0.32	0.23	0.17
		L/300	5.12	2.16	1.11	0.64	0.40	0.27	0.19	0.14
1,00	8,61	*	8.05	4.86	3.25	2.33	1.75	1.36	1.09	0.89
		L/200	8.05	3.78	1.94	1.12	0.71	0.47	0.33	0.24
		L/250	7.17	3.02	1.55	0.90	0.56	0.38	0.27	0.19
		L/300	5.97	2.52	1.29	0.75	0.47	0.32	0.22	0.16
1,25	10,76	*	10.40	6.20	4.11	2.93	2.19	1.70	1.36	1.11
		L/200	10.40	4.91	2.51	1.45	0.92	0.61	0.43	0.31
		L/250	9.31	3.93	2.01	1.16	0.73	0.49	0.34	0.25
		L/300	7.76	3.27	1.68	0.97	0.61	0.41	0.29	0.21
1,50	12,91	*	12.66	7.48	4.94	3.50	2.61	2.03	1.61	1.32
		L/200	12.66	6.02	3.08	1.78	1.12	0.75	0.53	0.39
		L/250	11.42	4.82	2.47	1.43	0.90	0.60	0.42	0.31
		L/300	9.52	4.02	2.06	1.19	0.75	0.50	0.35	0.26

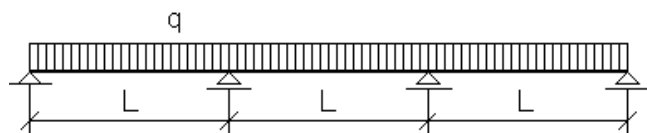

STEPRO A,eff

Oceľ S 280 GD

t	g	Kritérium pre	Medzné zaťaženie q [kN/m^2] pre rozpätie L [m]							
[mm]	[kg/m^2]	* pevnosť δ_{max}	0,75	1,00	1,25	1,50	1,75	2,00	2,25	2,50
0,40	3,44	*	2.59	1.69	1.20	0.90	0.70	0.56	0.46	0.38
		$L/200$	2.30	0.97	0.50	0.29	0.18	0.12	0.09	0.06
		$L/250$	1.84	0.78	0.40	0.23	0.14	0.10	0.07	0.05
		$L/300$	1.53	0.65	0.33	0.19	0.12	0.08	0.06	0.04
0,50	4,30	*	3.69	2.37	1.65	1.22	0.94	0.75	0.61	0.51
		$L/200$	3.04	1.28	0.66	0.38	0.24	0.16	0.11	0.08
		$L/250$	2.43	1.03	0.52	0.30	0.19	0.13	0.09	0.07
		$L/300$	2.03	0.85	0.44	0.25	0.16	0.11	0.08	0.05
0,60	5,16	*	4.81	3.05	2.11	1.55	1.18	0.94	0.76	0.63
		$L/200$	3.81	1.61	0.82	0.48	0.30	0.20	0.14	0.10
		$L/250$	3.05	1.29	0.66	0.38	0.24	0.16	0.11	0.08
		$L/300$	2.54	1.07	0.55	0.32	0.20	0.13	0.09	0.07
0,70	6,02	*	5.97	3.73	2.56	1.87	1.42	1.12	0.91	0.75
		$L/200$	4.61	1.95	1.00	0.58	0.36	0.24	0.17	0.12
		$L/250$	3.69	1.56	0.80	0.46	0.29	0.19	0.14	0.10
		$L/300$	3.08	1.30	0.66	0.38	0.24	0.16	0.11	0.08
0,75	6,46	*	6.55	4.07	2.78	2.03	1.54	1.21	0.98	0.81
		$L/200$	5.02	2.12	1.08	0.63	0.40	0.26	0.19	0.14
		$L/250$	4.02	1.69	0.87	0.50	0.32	0.21	0.15	0.11
		$L/300$	3.35	1.41	0.72	0.42	0.26	0.18	0.12	0.09
0,88	7,57	*	8.06	4.96	3.37	2.44	1.84	1.44	1.16	0.96
		$L/200$	6.10	2.57	1.32	0.76	0.48	0.32	0.23	0.16
		$L/250$	4.88	2.06	1.05	0.61	0.38	0.26	0.18	0.13
		$L/300$	4.07	1.72	0.88	0.51	0.32	0.21	0.15	0.11
1,00	8,61	*	9.46	5.78	3.90	2.81	2.12	1.66	1.33	1.09
		$L/200$	7.12	3.00	1.54	0.89	0.56	0.38	0.26	0.19
		$L/250$	5.69	2.40	1.23	0.71	0.45	0.30	0.21	0.15
		$L/300$	4.74	2.00	1.02	0.59	0.37	0.25	0.18	0.13
1,25	10,76	*	12.34	7.44	4.97	3.56	2.67	2.08	1.67	1.36
		$L/200$	9.24	3.90	2.00	1.15	0.73	0.49	0.34	0.25
		$L/250$	7.39	3.12	1.60	0.92	0.58	0.39	0.27	0.20
		$L/300$	6.16	2.60	1.33	0.77	0.48	0.32	0.23	0.17
1,50	12,91	*	15.14	9.03	6.00	4.27	3.20	2.48	1.98	1.62
		$L/200$	11.34	4.78	2.45	1.42	0.89	0.60	0.42	0.31
		$L/250$	9.07	3.83	1.96	1.13	0.71	0.48	0.34	0.24
		$L/300$	7.56	3.19	1.63	0.94	0.59	0.40	0.28	0.20

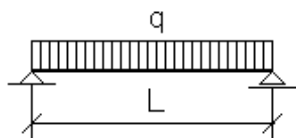

STEPRO A,eff

Oceľ S 320 GD

t	g	Kritérium pre	Medzné zaťaženie q [kN/m ²] pre rozpätie L [m]							
			0,75	1,00	1,25	1,50	1,75	2,00	2,25	2,50
[mm]	[kg/m ²]	* pevnosť δ_{max}								
0,40	3,44	*	3.46	1.95	1.25	0.86	0.64	0.49	0.38	0.31
		L/200	1.18	0.50	0.25	0.15	0.09	0.06	0.04	0.03
		L/250	0.94	0.40	0.20	0.12	0.07	0.05	0.03	0.03
		L/300	0.79	0.33	0.17	0.10	0.06	0.04	0.03	0.02
0,50	4,30	*	4.74	2.67	1.71	1.18	0.87	0.67	0.53	0.43
		L/200	1.55	0.66	0.34	0.19	0.12	0.08	0.06	0.04
		L/250	1.24	0.52	0.27	0.16	0.10	0.07	0.05	0.03
		L/300	1.04	0.44	0.22	0.13	0.08	0.05	0.04	0.03
0,60	5,16	*	6.16	3.46	2.22	1.54	1.13	0.87	0.68	0.55
		L/200	1.95	0.82	0.42	0.24	0.15	0.10	0.07	0.05
		L/250	1.56	0.66	0.34	0.19	0.12	0.08	0.06	0.04
		L/300	1.30	0.55	0.28	0.16	0.10	0.07	0.05	0.04
0,70	6,02	*	7.70	4.33	2.77	1.93	1.41	1.08	0.86	0.69
		L/200	2.36	0.99	0.51	0.29	0.19	0.12	0.09	0.06
		L/250	1.89	0.80	0.41	0.24	0.15	0.10	0.07	0.05
		L/300	1.57	0.66	0.34	0.20	0.12	0.08	0.06	0.04
0,75	6,46	*	8.52	4.79	3.07	2.13	1.56	1.20	0.95	0.77
		L/200	2.57	1.08	0.55	0.32	0.20	0.14	0.10	0.07
		L/250	2.05	0.87	0.44	0.26	0.16	0.11	0.08	0.06
		L/300	1.71	0.72	0.37	0.21	0.13	0.09	0.06	0.05
0,88	7,57	*	10.76	6.05	3.87	2.69	1.98	1.51	1.20	0.97
		L/200	3.12	1.32	0.67	0.39	0.25	0.16	0.12	0.08
		L/250	2.50	1.05	0.54	0.31	0.20	0.13	0.09	0.07
		L/300	2.08	0.88	0.45	0.26	0.16	0.11	0.08	0.06
1,00	8,61	*	12.97	7.29	4.67	3.24	2.38	1.82	1.44	1.17
		L/200	3.64	1.53	0.79	0.45	0.29	0.19	0.13	0.10
		L/250	2.91	1.23	0.63	0.36	0.23	0.15	0.11	0.08
		L/300	2.42	1.02	0.52	0.30	0.19	0.13	0.09	0.07
1,25	10,76	*	17.90	10.07	6.44	4.47	3.29	2.52	1.99	1.61
		L/200	4.72	1.99	1.02	0.59	0.37	0.25	0.17	0.13
		L/250	3.78	1.59	0.82	0.47	0.30	0.20	0.14	0.10
		L/300	3.15	1.33	0.68	0.39	0.25	0.17	0.12	0.09
1,50	12,91	*	23.14	13.01	8.33	5.78	4.25	3.25	2.57	2.08
		L/200	5.80	2.45	1.25	0.73	0.46	0.31	0.21	0.16
		L/250	4.64	1.96	1.00	0.58	0.37	0.24	0.17	0.13
		L/300	3.87	1.63	0.84	0.48	0.30	0.20	0.14	0.10

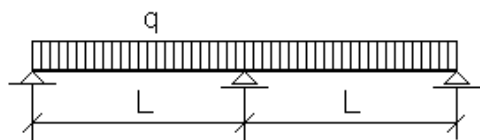

STEPRO A,eff

Oceľ S 320 GD

t	g	Kritérium pre	Medzné zaťaženie q [kN/m ²] pre rozpätie L [m]									
			[mm]	[kg/m ²]	* pevnosť δ _{max}	0,75	1,00	1,25	1,50	1,75	2,00	2,25
0,40	3,44	*			2,54	1,64	1,15	0,85	0,66	0,53	0,43	0,36
		L/200			2,54	1,20	0,61	0,36	0,22	0,15	0,11	0,08
		L/250			2,27	0,96	0,49	0,28	0,18	0,12	0,08	0,06
		L/300			1,89	0,80	0,41	0,24	0,15	0,10	0,07	0,05
0,50	4,30	*			3,61	2,29	1,59	1,17	0,90	0,71	0,58	0,48
		L/200			3,61	1,58	0,81	0,47	0,29	0,20	0,14	0,10
		L/250			3,00	1,26	0,65	0,37	0,24	0,16	0,11	0,08
		L/300			2,50	1,05	0,54	0,31	0,20	0,13	0,09	0,07
0,60	5,16	*			4,68	2,93	2,01	1,47	1,12	0,88	0,71	0,59
		L/200			4,68	1,98	1,01	0,59	0,37	0,25	0,17	0,13
		L/250			3,76	1,59	0,81	0,47	0,30	0,20	0,14	0,10
		L/300			3,13	1,32	0,68	0,39	0,25	0,17	0,12	0,08
0,70	6,02	*			5,76	3,57	2,43	1,77	1,34	1,05	0,85	0,70
		L/200			5,69	2,40	1,23	0,71	0,45	0,30	0,21	0,15
		L/250			4,55	1,92	0,98	0,57	0,36	0,24	0,17	0,12
		L/300			3,79	1,60	0,82	0,47	0,30	0,20	0,14	0,10
0,75	6,46	*			6,31	3,89	2,64	1,91	1,45	1,14	0,91	0,75
		L/200			6,19	2,61	1,34	0,77	0,49	0,33	0,23	0,17
		L/250			4,95	2,09	1,07	0,62	0,39	0,26	0,18	0,13
		L/300			4,13	1,74	0,89	0,52	0,32	0,22	0,15	0,11
0,88	7,57	*			7,73	4,72	3,18	2,29	1,73	1,35	1,08	0,89
		L/200			7,52	3,17	1,62	0,94	0,59	0,40	0,28	0,20
		L/250			6,02	2,54	1,30	0,75	0,47	0,32	0,22	0,16
		L/300			5,01	2,12	1,08	0,63	0,39	0,26	0,19	0,14
1,00	8,61	*			9,03	5,47	3,67	2,63	1,98	1,54	1,24	1,01
		L/200			8,77	3,70	1,89	1,10	0,69	0,46	0,32	0,24
		L/250			7,02	2,96	1,52	0,88	0,55	0,37	0,26	0,19
		L/300			5,85	2,47	1,26	0,73	0,46	0,31	0,22	0,16
1,25	10,76	*			11,70	7,00	4,65	3,32	2,49	1,93	1,54	1,26
		L/200			11,39	4,81	2,46	1,42	0,90	0,60	0,42	0,31
		L/250			9,11	3,84	1,97	1,14	0,72	0,48	0,34	0,25
		L/300			7,60	3,20	1,64	0,95	0,60	0,40	0,28	0,21
1,50	12,91	*			14,28	8,46	5,60	3,97	2,97	2,30	1,84	1,50
		L/200			13,99	5,90	3,02	1,75	1,10	0,74	0,52	0,38
		L/250			11,19	4,72	2,42	1,40	0,88	0,59	0,41	0,30
		L/300			9,33	3,94	2,02	1,17	0,73	0,49	0,35	0,25

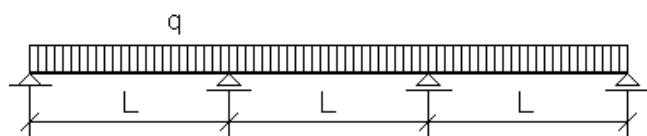

STEPRO A,eff

Oceľ S 320 GD

t	g	Kritérium pre	Medzné zaťaženie q [kN/m^2] pre rozpätie L [m]							
[mm]	[kg/m^2]	* pevnosť δ_{max}	0,75	1,00	1,25	1,50	1,75	2,00	2,25	2,50
0,40	3,44	*	2.83	1.85	1.32	0.99	0.77	0.62	0.51	0.42
		$L/200$	2.26	0.95	0.49	0.28	0.18	0.12	0.08	0.06
		$L/250$	1.81	0.76	0.39	0.23	0.14	0.10	0.07	0.05
		$L/300$	1.50	0.63	0.32	0.19	0.12	0.08	0.06	0.04
0,50	4,30	*	4.08	2.63	1.84	1.37	1.06	0.84	0.69	0.57
		$L/200$	2.98	1.26	0.64	0.37	0.23	0.16	0.11	0.08
		$L/250$	2.38	1.00	0.51	0.30	0.19	0.13	0.09	0.06
		$L/300$	1.98	0.84	0.43	0.25	0.16	0.10	0.07	0.05
0,60	5,16	*	5.34	3.39	2.35	1.73	1.33	1.05	0.85	0.71
		$L/200$	3.73	1.57	0.81	0.47	0.29	0.20	0.14	0.10
		$L/250$	2.99	1.26	0.64	0.37	0.23	0.16	0.11	0.08
		$L/300$	2.49	1.05	0.54	0.31	0.20	0.13	0.09	0.07
0,70	6,02	*	6.63	4.17	2.87	2.10	1.60	1.26	1.02	0.84
		$L/200$	4.51	1.90	0.98	0.56	0.36	0.24	0.17	0.12
		$L/250$	3.61	1.52	0.78	0.45	0.28	0.19	0.13	0.10
		$L/300$	3.01	1.27	0.65	0.38	0.24	0.16	0.11	0.08
0,75	6,46	*	7.29	4.56	3.12	2.28	1.74	1.37	1.10	0.91
		$L/200$	4.91	2.07	1.06	0.61	0.39	0.26	0.18	0.13
		$L/250$	3.93	1.66	0.85	0.49	0.31	0.21	0.15	0.11
		$L/300$	3.28	1.38	0.71	0.41	0.26	0.17	0.12	0.09
0,88	7,57	*	9.00	5.56	3.78	2.74	2.08	1.63	1.32	1.08
		$L/200$	5.97	2.52	1.29	0.75	0.47	0.31	0.22	0.16
		$L/250$	4.78	2.02	1.03	0.60	0.38	0.25	0.18	0.13
		$L/300$	3.98	1.68	0.86	0.50	0.31	0.21	0.15	0.11
1,00	8,61	*	10.59	6.49	4.39	3.17	2.39	1.87	1.51	1.24
		$L/200$	6.96	2.94	1.50	0.87	0.55	0.37	0.26	0.19
		$L/250$	5.57	2.35	1.20	0.70	0.44	0.29	0.21	0.15
		$L/300$	4.64	1.96	1.00	0.58	0.37	0.24	0.17	0.13
1,25	10,76	*	13.85	8.37	5.61	4.02	3.03	2.36	1.89	1.55
		$L/200$	9.05	3.82	1.95	1.13	0.71	0.48	0.34	0.24
		$L/250$	7.24	3.05	1.56	0.90	0.57	0.38	0.27	0.20
		$L/300$	6.03	2.54	1.30	0.75	0.47	0.32	0.22	0.16
1,50	12,91	*	17.04	10.20	6.78	4.84	3.63	2.82	2.25	1.84
		$L/200$	11.11	4.69	2.40	1.39	0.87	0.59	0.41	0.30
		$L/250$	8.89	3.75	1.92	1.11	0.70	0.47	0.33	0.24
		$L/300$	7.41	3.13	1.60	0.93	0.58	0.39	0.27	0.20

3.4 STEPPO-B,eff

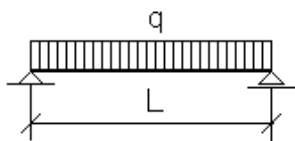

STEPPO B,eff

Oceľ S 220 GD

t	g	Kritérium pre	Medzné zaťaženie q [kN/m^2] pre rozpätie L [m]							
			$0,75$	$1,00$	$1,25$	$1,50$	$1,75$	$2,00$	$2,25$	$2,50$
[mm]	[kg/m ²]	* pevnosť δ_{max}								
0,40	3,44	*	2,96	1,66	1,06	0,74	0,54	0,42	0,33	0,27
		$L/200$	2,24	0,94	0,48	0,28	0,18	0,12	0,08	0,06
		$L/250$	1,79	0,76	0,39	0,22	0,14	0,09	0,07	0,05
		$L/300$	1,49	0,63	0,32	0,19	0,12	0,08	0,06	0,04
0,50	4,30	*	3,66	2,06	1,32	0,91	0,67	0,51	0,41	0,33
		$L/200$	2,76	1,17	0,60	0,35	0,22	0,15	0,10	0,07
		$L/250$	2,21	0,93	0,48	0,28	0,17	0,12	0,08	0,06
		$L/300$	1,84	0,78	0,40	0,23	0,15	0,10	0,07	0,05
0,60	5,16	*	4,34	2,44	1,56	1,09	0,80	0,61	0,48	0,39
		$L/200$	3,27	1,38	0,71	0,41	0,26	0,17	0,12	0,09
		$L/250$	2,62	1,11	0,57	0,33	0,21	0,14	0,10	0,07
		$L/300$	2,18	0,92	0,47	0,27	0,17	0,12	0,08	0,06
0,70	6,02	*	5,01	2,82	1,80	1,25	0,92	0,71	0,56	0,45
		$L/200$	3,77	1,59	0,81	0,47	0,30	0,20	0,14	0,10
		$L/250$	3,02	1,27	0,65	0,38	0,24	0,16	0,11	0,08
		$L/300$	2,51	1,06	0,54	0,31	0,20	0,13	0,09	0,07
0,75	6,46	*	5,34	3,01	1,92	1,34	0,98	0,75	0,59	0,48
		$L/200$	4,01	1,69	0,87	0,50	0,32	0,21	0,15	0,11
		$L/250$	3,21	1,35	0,69	0,40	0,25	0,17	0,12	0,09
		$L/300$	2,68	1,13	0,58	0,33	0,21	0,14	0,10	0,07
0,88	7,57	*	6,18	3,48	2,23	1,55	1,14	0,87	0,69	0,56
		$L/200$	4,63	1,95	1,00	0,58	0,36	0,24	0,17	0,13
		$L/250$	3,71	1,56	0,80	0,46	0,29	0,20	0,14	0,10
		$L/300$	3,09	1,30	0,67	0,39	0,24	0,16	0,11	0,08
1,00	8,61	*	6,94	3,90	2,50	1,73	1,27	0,98	0,77	0,62
		$L/200$	5,18	2,19	1,12	0,65	0,41	0,27	0,19	0,14
		$L/250$	4,15	1,75	0,90	0,52	0,33	0,22	0,15	0,11
		$L/300$	3,45	1,46	0,75	0,43	0,27	0,18	0,13	0,09
1,25	10,76	*	8,44	4,75	3,04	2,11	1,55	1,19	0,94	0,76
		$L/200$	6,27	2,65	1,35	0,78	0,49	0,33	0,23	0,17
		$L/250$	5,02	2,12	1,08	0,63	0,39	0,26	0,19	0,14
		$L/300$	4,18	1,76	0,90	0,52	0,33	0,22	0,15	0,11
1,50	12,91	*	9,86	5,55	3,55	2,47	1,81	1,39	1,10	0,89
		$L/200$	7,28	3,07	1,57	0,91	0,57	0,38	0,27	0,20
		$L/250$	5,83	2,46	1,26	0,73	0,46	0,31	0,22	0,16
		$L/300$	4,86	2,05	1,05	0,61	0,38	0,26	0,18	0,13

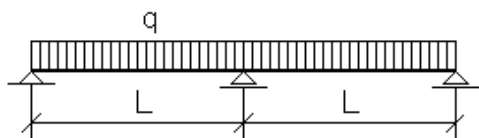

STEPRO B,eff

Oceľ S 220 GD

t	g	Kritérium pre	Medzné zaťaženie q [kN/m ²] pre rozpätie L [m]								
			[mm]	[kg/m ²]	* pevnosť δ _{max}	0,75	1,00	1,25	1,50	1,75	2,00
0,40	3,44	*		1,44	0,89	0,60	0,44	0,33	0,26	0,21	0,17
		L/200		1,44	0,89	0,60	0,44	0,33	0,26	0,20	0,15
		L/250		1,44	0,89	0,60	0,44	0,33	0,23	0,16	0,12
		L/300		1,44	0,89	0,60	0,44	0,28	0,19	0,13	0,10
0,50	4,30	*		2,09	1,28	0,86	0,62	0,47	0,37	0,30	0,24
		L/200		2,09	1,28	0,86	0,62	0,47	0,35	0,25	0,18
		L/250		2,09	1,28	0,86	0,62	0,42	0,28	0,20	0,14
		L/300		2,09	1,28	0,86	0,56	0,35	0,23	0,16	0,12
0,60	5,16	*		2,83	1,72	1,16	0,83	0,63	0,49	0,39	0,32
		L/200		2,83	1,72	1,16	0,83	0,62	0,42	0,29	0,21
		L/250		2,83	1,72	1,16	0,79	0,50	0,33	0,23	0,17
		L/300		2,83	1,72	1,14	0,66	0,41	0,28	0,19	0,14
0,70	6,02	*		3,64	2,20	1,48	1,06	0,80	0,62	0,50	0,41
		L/200		3,64	2,20	1,48	1,06	0,72	0,48	0,34	0,25
		L/250		3,64	2,20	1,48	0,91	0,57	0,38	0,27	0,20
		L/300		3,64	2,20	1,31	0,76	0,48	0,32	0,22	0,16
0,75	6,46	*		4,08	2,46	1,65	1,18	0,89	0,69	0,55	0,45
		L/200		4,08	2,46	1,65	1,18	0,76	0,51	0,36	0,26
		L/250		4,08	2,46	1,65	0,97	0,61	0,41	0,29	0,21
		L/300		4,08	2,46	1,39	0,81	0,51	0,34	0,24	0,17
0,88	7,57	*		5,28	3,17	2,12	1,52	1,14	0,88	0,71	0,58
		L/200		5,28	3,17	2,12	1,40	0,88	0,59	0,41	0,30
		L/250		5,28	3,17	1,93	1,12	0,70	0,47	0,33	0,24
		L/300		5,28	3,14	1,61	0,93	0,59	0,39	0,28	0,20
1,00	8,61	*		6,48	3,88	2,59	1,85	1,38	1,08	0,86	0,70
		L/200		6,48	3,88	2,59	1,56	0,98	0,66	0,46	0,34
		L/250		6,48	3,88	2,16	1,25	0,79	0,53	0,37	0,27
		L/300		6,48	3,51	1,80	1,04	0,66	0,44	0,31	0,22
1,25	10,76	*		9,20	5,49	3,64	2,59	1,94	1,51	1,20	0,98
		L/200		9,20	5,49	3,27	1,89	1,19	0,80	0,56	0,41
		L/250		9,20	5,10	2,61	1,51	0,95	0,64	0,45	0,33
		L/300		9,20	4,25	2,18	1,26	0,79	0,53	0,37	0,27
1,50	12,91	*		12,15	7,21	4,77	3,39	2,54	1,97	1,57	1,28
		L/200		12,15	7,21	3,79	2,20	1,38	0,93	0,65	0,47
		L/250		12,15	5,93	3,03	1,76	1,11	0,74	0,52	0,38
		L/300		11,71	4,94	2,53	1,46	0,92	0,62	0,43	0,32

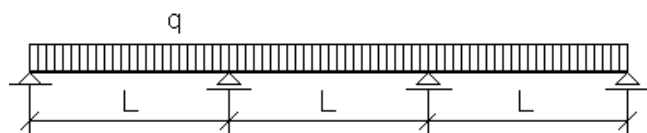

STEPRO B,eff

Oceľ S 220 GD

t	g	Kritérium pre	Medzné zaťaženie q [kN/m^2] pre rozpätie L [m]							
[mm]	[kg/m^2]	* pevnosť δ_{max}	0,75	1,00	1,25	1,50	1,75	2,00	2,25	2,50
0,40	3,44	*	2.05	1.31	0.92	0.68	0.52	0.42	0.34	0.28
		L/200	2.05	1.31	0.92	0.54	0.34	0.23	0.16	0.12
		L/250	2.05	1.31	0.74	0.43	0.27	0.18	0.13	0.09
		L/300	2.05	1.21	0.62	0.36	0.23	0.15	0.11	0.08
0,50	4,30	*	3.04	1.93	1.34	0.98	0.76	0.60	0.49	0.40
		L/200	3.04	1.93	1.14	0.66	0.42	0.28	0.20	0.14
		L/250	3.04	1.79	0.91	0.53	0.33	0.22	0.16	0.11
		L/300	3.04	1.49	0.76	0.44	0.28	0.19	0.13	0.10
0,60	5,16	*	4.16	2.62	1.81	1.33	1.01	0.80	0.65	0.54
		L/200	4.16	2.62	1.35	0.78	0.49	0.33	0.23	0.17
		L/250	4.16	2.12	1.08	0.63	0.39	0.26	0.19	0.14
		L/300	4.16	1.76	0.90	0.52	0.33	0.22	0.15	0.11
0,70	6,02	*	5.42	3.40	2.33	1.71	1.30	1.03	0.83	0.68
		L/200	5.42	3.05	1.56	0.90	0.57	0.38	0.27	0.19
		L/250	5.42	2.44	1.25	0.72	0.45	0.30	0.21	0.16
		L/300	4.81	2.03	1.04	0.60	0.38	0.25	0.18	0.13
0,75	6,46	*	6.09	3.81	2.61	1.91	1.45	1.14	0.93	0.76
		L/200	6.09	3.24	1.66	0.96	0.61	0.41	0.28	0.21
		L/250	6.09	2.59	1.33	0.77	0.48	0.32	0.23	0.17
		L/300	5.12	2.16	1.11	0.64	0.40	0.27	0.19	0.14
0,88	7,57	*	7.97	4.96	3.39	2.47	1.88	1.47	1.19	0.98
		L/200	7.97	3.74	1.92	1.11	0.70	0.47	0.33	0.24
		L/250	7.09	2.99	1.53	0.89	0.56	0.37	0.26	0.19
		L/300	5.91	2.49	1.28	0.74	0.47	0.31	0.22	0.16
1,00	8,61	*	9.86	6.11	4.16	3.02	2.29	1.80	1.45	1.20
		L/200	9.86	4.19	2.14	1.24	0.78	0.52	0.37	0.27
		L/250	7.94	3.35	1.71	0.99	0.62	0.42	0.29	0.21
		L/300	6.61	2.79	1.43	0.83	0.52	0.35	0.24	0.18
1,25	10,76	*	14.19	8.73	5.92	4.28	3.24	2.54	2.05	1.68
		L/200	12.01	5.07	2.59	1.50	0.95	0.63	0.44	0.32
		L/250	9.60	4.05	2.07	1.20	0.76	0.51	0.36	0.26
		L/300	8.00	3.38	1.73	1.00	0.63	0.42	0.30	0.22
1,50	12,91	*	18.95	11.59	7.83	5.65	4.27	3.34	2.68	2.20
		L/200	13.95	5.88	3.01	1.74	1.10	0.74	0.52	0.38
		L/250	11.16	4.71	2.41	1.39	0.88	0.59	0.41	0.30
		L/300	9.30	3.92	2.01	1.16	0.73	0.49	0.34	0.25

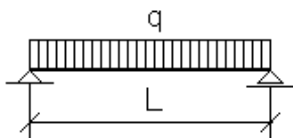

STEPRO B,eff

Oceľ S 250 GD

t	g	Kritérium pre	Medzné zaťaženie q [kN/m^2] pre rozpätie L [m]							
[mm]	[kg/m^2]	* pevnosť δ_{max}	0,75	1,00	1,25	1,50	1,75	2,00	2,25	2,50
0,40	3,44	*	3.36	1.89	1.21	0.84	0.62	0.47	0.37	0.30
		$L/200$	2.24	0.94	0.48	0.28	0.18	0.12	0.08	0.06
		$L/250$	1.79	0.76	0.39	0.22	0.14	0.09	0.07	0.05
		$L/300$	1.49	0.63	0.32	0.19	0.12	0.08	0.06	0.04
0,50	4,30	*	4.16	2.34	1.50	1.04	0.76	0.58	0.46	0.37
		$L/200$	2.76	1.17	0.60	0.35	0.22	0.15	0.10	0.07
		$L/250$	2.21	0.93	0.48	0.28	0.17	0.12	0.08	0.06
		$L/300$	1.84	0.78	0.40	0.23	0.15	0.10	0.07	0.05
0,60	5,16	*	4.94	2.78	1.78	1.23	0.91	0.69	0.55	0.44
		$L/200$	3.27	1.38	0.71	0.41	0.26	0.17	0.12	0.09
		$L/250$	2.62	1.11	0.57	0.33	0.21	0.14	0.10	0.07
		$L/300$	2.18	0.92	0.47	0.27	0.17	0.12	0.08	0.06
0,70	6,02	*	5.70	3.20	2.05	1.42	1.05	0.80	0.63	0.51
		$L/200$	3.77	1.59	0.81	0.47	0.30	0.20	0.14	0.10
		$L/250$	3.02	1.27	0.65	0.38	0.24	0.16	0.11	0.08
		$L/300$	2.51	1.06	0.54	0.31	0.20	0.13	0.09	0.07
0,75	6,46	*	6.07	3.42	2.19	1.52	1.12	0.85	0.67	0.55
		$L/200$	4.01	1.69	0.87	0.50	0.32	0.21	0.15	0.11
		$L/250$	3.21	1.35	0.69	0.40	0.25	0.17	0.12	0.09
		$L/300$	2.68	1.13	0.58	0.33	0.21	0.14	0.10	0.07
0,88	7,57	*	7.03	3.95	2.53	1.76	1.29	0.99	0.78	0.63
		$L/200$	4.63	1.95	1.00	0.58	0.36	0.24	0.17	0.13
		$L/250$	3.71	1.56	0.80	0.46	0.29	0.20	0.14	0.10
		$L/300$	3.09	1.30	0.67	0.39	0.24	0.16	0.11	0.08
1,00	8,61	*	7.88	4.43	2.84	1.97	1.45	1.11	0.88	0.71
		$L/200$	5.18	2.19	1.12	0.65	0.41	0.27	0.19	0.14
		$L/250$	4.15	1.75	0.90	0.52	0.33	0.22	0.15	0.11
		$L/300$	3.45	1.46	0.75	0.43	0.27	0.18	0.13	0.09
1,25	10,76	*	9.59	5.40	3.45	2.40	1.76	1.35	1.07	0.86
		$L/200$	6.27	2.65	1.35	0.78	0.49	0.33	0.23	0.17
		$L/250$	5.02	2.12	1.08	0.63	0.39	0.26	0.19	0.14
		$L/300$	4.18	1.76	0.90	0.52	0.33	0.22	0.15	0.11
1,50	12,91	*	11.21	6.31	4.04	2.80	2.06	1.58	1.25	1.01
		$L/200$	7.28	3.07	1.57	0.91	0.57	0.38	0.27	0.20
		$L/250$	5.83	2.46	1.26	0.73	0.46	0.31	0.22	0.16
		$L/300$	4.86	2.05	1.05	0.61	0.38	0.26	0.18	0.13

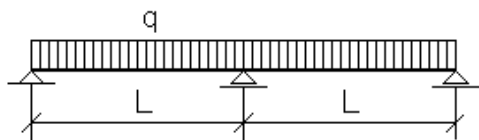

STEPRO B,eff

Oceľ S 250 GD

t	g	Kritérium pre	Medzné zaťaženie q [kN/m^2] pre rozpätie L [m]							
[mm]	[kg/m^2]	* pevnosť δ_{max}	0,75	1,00	1,25	1,50	1,75	2,00	2,25	2,50
0,40	3,44	*	1.57	0.97	0.66	0.48	0.36	0.29	0.23	0.19
		L/200	1.57	0.97	0.66	0.48	0.36	0.28	0.20	0.15
		L/250	1.57	0.97	0.66	0.48	0.34	0.23	0.16	0.12
		L/300	1.57	0.97	0.66	0.45	0.28	0.19	0.13	0.10
0,50	4,30	*	2.28	1.40	0.94	0.68	0.51	0.40	0.32	0.27
		L/200	2.28	1.40	0.94	0.68	0.51	0.35	0.25	0.18
		L/250	2.28	1.40	0.94	0.67	0.42	0.28	0.20	0.14
		L/300	2.28	1.40	0.94	0.56	0.35	0.23	0.16	0.12
0,60	5,16	*	3.08	1.87	1.26	0.91	0.68	0.53	0.43	0.35
		L/200	3.08	1.87	1.26	0.91	0.62	0.42	0.29	0.21
		L/250	3.08	1.87	1.26	0.79	0.50	0.33	0.23	0.17
		L/300	3.08	1.87	1.14	0.66	0.41	0.28	0.19	0.14
0,70	6,02	*	3.96	2.40	1.61	1.15	0.87	0.68	0.54	0.45
		L/200	3.96	2.40	1.61	1.14	0.72	0.48	0.34	0.25
		L/250	3.96	2.40	1.57	0.91	0.57	0.38	0.27	0.20
		L/300	3.96	2.40	1.31	0.76	0.48	0.32	0.22	0.16
0,75	6,46	*	4.43	2.68	1.79	1.29	0.97	0.75	0.60	0.50
		L/200	4.43	2.68	1.79	1.21	0.76	0.51	0.36	0.26
		L/250	4.43	2.68	1.67	0.97	0.61	0.41	0.29	0.21
		L/300	4.43	2.68	1.39	0.81	0.51	0.34	0.24	0.17
0,88	7,57	*	5.73	3.45	2.31	1.65	1.24	0.96	0.77	0.63
		L/200	5.73	3.45	2.31	1.40	0.88	0.59	0.41	0.30
		L/250	5.73	3.45	1.93	1.12	0.70	0.47	0.33	0.24
		L/300	5.73	3.14	1.61	0.93	0.59	0.39	0.28	0.20
1,00	8,61	*	7.04	4.22	2.81	2.01	1.51	1.17	0.94	0.77
		L/200	7.04	4.22	2.70	1.56	0.98	0.66	0.46	0.34
		L/250	7.04	4.22	2.16	1.25	0.79	0.53	0.37	0.27
		L/300	7.04	3.51	1.80	1.04	0.66	0.44	0.31	0.22
1,25	10,76	*	9.99	5.96	3.96	2.82	2.11	1.64	1.31	1.07
		L/200	9.99	5.96	3.27	1.89	1.19	0.80	0.56	0.41
		L/250	9.99	5.10	2.61	1.51	0.95	0.64	0.45	0.33
		L/300	9.99	4.25	2.18	1.26	0.79	0.53	0.37	0.27
1,50	12,91	*	13.20	7.84	5.19	3.69	2.76	2.14	1.71	1.40
		L/200	13.20	7.41	3.79	2.20	1.38	0.93	0.65	0.47
		L/250	13.20	5.93	3.03	1.76	1.11	0.74	0.52	0.38
		L/300	11.71	4.94	2.53	1.46	0.92	0.62	0.43	0.32

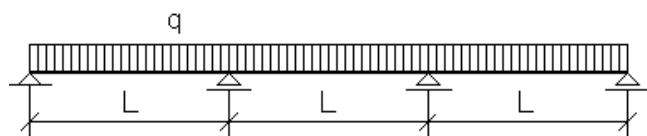

STEPRO B,eff

Oceľ S 250 GD

t	g	Kritérium pre	Medzné zaťaženie q [kN/m ²] pre rozpätie L [m]							
[mm]	[kg/m ²]	* pevnosť δ_{max}	0,75	1,00	1,25	1,50	1,75	2,00	2,25	2,50
0,40	3,44	*	2.22	1.43	1.00	0.74	0.57	0.46	0.37	0.31
		L/200	2.22	1.43	0.93	0.54	0.34	0.23	0.16	0.12
		L/250	2.22	1.43	0.74	0.43	0.27	0.18	0.13	0.09
		L/300	2.22	1.21	0.62	0.36	0.23	0.15	0.11	0.08
0,50	4,30	*	3.29	2.09	1.46	1.07	0.82	0.65	0.53	0.44
		L/200	3.29	2.09	1.14	0.66	0.42	0.28	0.20	0.14
		L/250	3.29	1.79	0.91	0.53	0.33	0.22	0.16	0.11
		L/300	3.29	1.49	0.76	0.44	0.28	0.19	0.13	0.10
0,60	5,16	*	4.51	2.85	1.97	1.44	1.11	0.87	0.71	0.59
		L/200	4.51	2.65	1.35	0.78	0.49	0.33	0.23	0.17
		L/250	4.51	2.12	1.08	0.63	0.39	0.26	0.19	0.14
		L/300	4.18	1.76	0.90	0.52	0.33	0.22	0.15	0.11
0,70	6,02	*	5.87	3.69	2.54	1.85	1.42	1.12	0.90	0.75
		L/200	5.87	3.05	1.56	0.90	0.57	0.38	0.27	0.19
		L/250	5.78	2.44	1.25	0.72	0.45	0.30	0.21	0.16
		L/300	4.81	2.03	1.04	0.60	0.38	0.25	0.18	0.13
0,75	6,46	*	6.59	4.13	2.84	2.07	1.58	1.25	1.01	0.83
		L/200	6.59	3.24	1.66	0.96	0.61	0.41	0.28	0.21
		L/250	6.15	2.59	1.33	0.77	0.48	0.32	0.23	0.17
		L/300	5.12	2.16	1.11	0.64	0.40	0.27	0.19	0.14
0,88	7,57	*	8.63	5.38	3.68	2.68	2.04	1.60	1.30	1.07
		L/200	8.63	3.74	1.92	1.11	0.70	0.47	0.33	0.24
		L/250	7.09	2.99	1.53	0.89	0.56	0.37	0.26	0.19
		L/300	5.91	2.49	1.28	0.74	0.47	0.31	0.22	0.16
1,00	8,61	*	10.67	6.62	4.52	3.28	2.49	1.96	1.58	1.30
		L/200	9.92	4.19	2.14	1.24	0.78	0.52	0.37	0.27
		L/250	7.94	3.35	1.71	0.99	0.62	0.42	0.29	0.21
		L/300	6.61	2.79	1.43	0.83	0.52	0.35	0.24	0.18
1,25	10,76	*	15.36	9.47	6.43	4.65	3.52	2.76	2.22	1.83
		L/200	12.01	5.07	2.59	1.50	0.95	0.63	0.44	0.32
		L/250	9.60	4.05	2.07	1.20	0.76	0.51	0.36	0.26
		L/300	8.00	3.38	1.73	1.00	0.63	0.42	0.30	0.22
1,50	12,91	*	20.53	12.58	8.50	6.14	4.64	3.63	2.92	2.40
		L/200	13.95	5.88	3.01	1.74	1.10	0.74	0.52	0.38
		L/250	11.16	4.71	2.41	1.39	0.88	0.59	0.41	0.30
		L/300	9.30	3.92	2.01	1.16	0.73	0.49	0.34	0.25

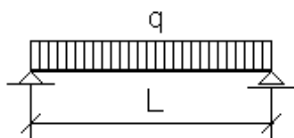

STEPRO B,eff

Oceľ S 280 GD

t	g	Kritérium pre	Medzné zaťaženie q [kN/m^2] pre rozpätie L [m]							
[mm]	[kg/m^2]	* pevnosť δ_{max}	0,75	1,00	1,25	1,50	1,75	2,00	2,25	2,50
0,40	3,44	*	3.69	2.10	1.35	0.93	0.69	0.53	0.42	0.34
		$L/200$	2.23	0.94	0.48	0.28	0.18	0.12	0.08	0.06
		$L/250$	1.78	0.75	0.38	0.22	0.14	0.09	0.07	0.05
		$L/300$	1.48	0.63	0.32	0.19	0.12	0.08	0.05	0.04
0,50	4,30	*	4.66	2.62	1.68	1.16	0.86	0.65	0.52	0.42
		$L/200$	2.76	1.17	0.60	0.35	0.22	0.15	0.10	0.07
		$L/250$	2.21	0.93	0.48	0.28	0.17	0.12	0.08	0.06
		$L/300$	1.84	0.78	0.40	0.23	0.15	0.10	0.07	0.05
0,60	5,16	*	5.53	3.11	1.99	1.38	1.02	0.78	0.61	0.50
		$L/200$	3.27	1.38	0.71	0.41	0.26	0.17	0.12	0.09
		$L/250$	2.62	1.11	0.57	0.33	0.21	0.14	0.10	0.07
		$L/300$	2.18	0.92	0.47	0.27	0.17	0.12	0.08	0.06
0,70	6,02	*	6.38	3.59	2.30	1.60	1.17	0.90	0.71	0.57
		$L/200$	3.77	1.59	0.81	0.47	0.30	0.20	0.14	0.10
		$L/250$	3.02	1.27	0.65	0.38	0.24	0.16	0.11	0.08
		$L/300$	2.51	1.06	0.54	0.31	0.20	0.13	0.09	0.07
0,75	6,46	*	6.80	3.83	2.45	1.70	1.25	0.96	0.76	0.61
		$L/200$	4.01	1.69	0.87	0.50	0.32	0.21	0.15	0.11
		$L/250$	3.21	1.35	0.69	0.40	0.25	0.17	0.12	0.09
		$L/300$	2.68	1.13	0.58	0.33	0.21	0.14	0.10	0.07
0,88	7,57	*	7.87	4.43	2.83	1.97	1.45	1.11	0.87	0.71
		$L/200$	4.63	1.95	1.00	0.58	0.36	0.24	0.17	0.13
		$L/250$	3.71	1.56	0.80	0.46	0.29	0.20	0.14	0.10
		$L/300$	3.09	1.30	0.67	0.39	0.24	0.16	0.11	0.08
1,00	8,61	*	8.83	4.97	3.18	2.21	1.62	1.24	0.98	0.79
		$L/200$	5.18	2.19	1.12	0.65	0.41	0.27	0.19	0.14
		$L/250$	4.15	1.75	0.90	0.52	0.33	0.22	0.15	0.11
		$L/300$	3.45	1.46	0.75	0.43	0.27	0.18	0.13	0.09
1,25	10,76	*	10.75	6.04	3.87	2.69	1.97	1.51	1.19	0.97
		$L/200$	6.27	2.65	1.35	0.78	0.49	0.33	0.23	0.17
		$L/250$	5.02	2.12	1.08	0.63	0.39	0.26	0.19	0.14
		$L/300$	4.18	1.76	0.90	0.52	0.33	0.22	0.15	0.11
1,50	12,91	*	12.55	7.06	4.52	3.14	2.31	1.77	1.39	1.13
		$L/200$	7.28	3.07	1.57	0.91	0.57	0.38	0.27	0.20
		$L/250$	5.83	2.46	1.26	0.73	0.46	0.31	0.22	0.16
		$L/300$	4.86	2.05	1.05	0.61	0.38	0.26	0.18	0.13

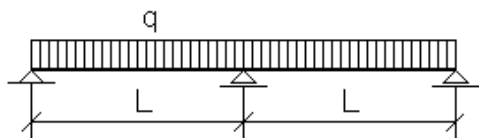

STEPRO B,eff

Oceľ S 280 GD

t	g	Kritérium pre	Medzné zaťaženie q [kN/m ²] pre rozpätie L [m]							
[mm]	[kg/m ²]	* pevnosť δ_{max}	0,75	1,00	1,25	1,50	1,75	2,00	2,25	2,50
0,40	3,44	*	1.69	1.05	0.72	0.52	0.39	0.31	0.25	0.21
		L/200	1.69	1.05	0.72	0.52	0.39	0.28	0.20	0.14
		L/250	1.69	1.05	0.72	0.52	0.34	0.23	0.16	0.12
		L/300	1.69	1.05	0.72	0.45	0.28	0.19	0.13	0.10
0,50	4,30	*	2.46	1.51	1.02	0.74	0.56	0.44	0.35	0.29
		L/200	2.46	1.51	1.02	0.74	0.52	0.35	0.25	0.18
		L/250	2.46	1.51	1.02	0.67	0.42	0.28	0.20	0.14
		L/300	2.46	1.51	0.96	0.56	0.35	0.23	0.16	0.12
0,60	5,16	*	3.32	2.02	1.36	0.98	0.74	0.58	0.46	0.38
		L/200	3.32	2.02	1.36	0.98	0.62	0.42	0.29	0.21
		L/250	3.32	2.02	1.36	0.79	0.50	0.33	0.23	0.17
		L/300	3.32	2.02	1.14	0.66	0.41	0.28	0.19	0.14
0,70	6,02	*	4.26	2.59	1.74	1.25	0.94	0.73	0.59	0.48
		L/200	4.26	2.59	1.74	1.14	0.72	0.48	0.34	0.25
		L/250	4.26	2.59	1.57	0.91	0.57	0.38	0.27	0.20
		L/300	4.26	2.56	1.31	0.76	0.48	0.32	0.22	0.16
0,75	6,46	*	4.77	2.89	1.94	1.39	1.04	0.81	0.65	0.54
		L/200	4.77	2.89	1.94	1.21	0.76	0.51	0.36	0.26
		L/250	4.77	2.89	1.67	0.97	0.61	0.41	0.29	0.21
		L/300	4.77	2.72	1.39	0.81	0.51	0.34	0.24	0.17
0,88	7,57	*	6.17	3.72	2.49	1.78	1.34	1.04	0.83	0.68
		L/200	6.17	3.72	2.41	1.40	0.88	0.59	0.41	0.30
		L/250	6.17	3.72	1.93	1.12	0.70	0.47	0.33	0.24
		L/300	6.17	3.14	1.61	0.93	0.59	0.39	0.28	0.20
1,00	8,61	*	7.57	4.55	3.03	2.17	1.63	1.27	1.01	0.83
		L/200	7.57	4.55	2.70	1.56	0.98	0.66	0.46	0.34
		L/250	7.57	4.22	2.16	1.25	0.79	0.53	0.37	0.27
		L/300	7.57	3.51	1.80	1.04	0.66	0.44	0.31	0.22
1,25	10,76	*	10.75	6.42	4.27	3.04	2.28	1.77	1.41	1.16
		L/200	10.75	6.38	3.27	1.89	1.19	0.80	0.56	0.41
		L/250	10.75	5.10	2.61	1.51	0.95	0.64	0.45	0.33
		L/300	10.08	4.25	2.18	1.26	0.79	0.53	0.37	0.27
1,50	12,91	*	14.20	8.45	5.60	3.98	2.98	2.31	1.84	1.51
		L/200	14.20	7.41	3.79	2.20	1.38	0.93	0.65	0.47
		L/250	14.05	5.93	3.03	1.76	1.11	0.74	0.52	0.38
		L/300	11.71	4.94	2.53	1.46	0.92	0.62	0.43	0.32

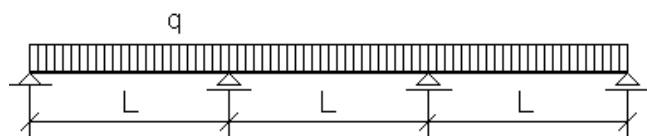

STEPRO B,eff

Oceľ S 280 GD

t	g	Kritérium pre	Medzné zaťaženie q [kN/m^2] pre rozpätie L [m]							
[mm]	[kg/m^2]	* pevnosť δ_{max}	0,75	1,00	1,25	1,50	1,75	2,00	2,25	2,50
0,40	3,44	*	2.38	1.54	1.08	0.80	0.62	0.49	0.40	0.33
		L/200	2.38	1.54	0.92	0.53	0.34	0.22	0.16	0.12
		L/250	2.38	1.44	0.74	0.43	0.27	0.18	0.13	0.09
		L/300	2.38	1.20	0.61	0.36	0.22	0.15	0.11	0.08
0,50	4,30	*	3.53	2.25	1.57	1.16	0.89	0.71	0.57	0.48
		L/200	3.53	2.23	1.14	0.66	0.42	0.28	0.20	0.14
		L/250	3.53	1.79	0.91	0.53	0.33	0.22	0.16	0.11
		L/300	3.53	1.49	0.76	0.44	0.28	0.19	0.13	0.10
0,60	5,16	*	4.84	3.06	2.12	1.56	1.19	0.94	0.76	0.63
		L/200	4.84	2.65	1.35	0.78	0.49	0.33	0.23	0.17
		L/250	4.84	2.12	1.08	0.63	0.39	0.26	0.19	0.14
		L/300	4.18	1.76	0.90	0.52	0.33	0.22	0.15	0.11
0,70	6,02	*	6.30	3.96	2.73	2.00	1.53	1.20	0.98	0.81
		L/200	6.30	3.05	1.56	0.90	0.57	0.38	0.27	0.19
		L/250	5.78	2.44	1.25	0.72	0.45	0.30	0.21	0.16
		L/300	4.81	2.03	1.04	0.60	0.38	0.25	0.18	0.13
0,75	6,46	*	7.08	4.44	3.06	2.23	1.70	1.34	1.09	0.90
		L/200	7.08	3.24	1.66	0.96	0.61	0.41	0.28	0.21
		L/250	6.15	2.59	1.33	0.77	0.48	0.32	0.23	0.17
		L/300	5.12	2.16	1.11	0.64	0.40	0.27	0.19	0.14
0,88	7,57	*	9.26	5.78	3.96	2.88	2.20	1.73	1.40	1.15
		L/200	8.87	3.74	1.92	1.11	0.70	0.47	0.33	0.24
		L/250	7.09	2.99	1.53	0.89	0.56	0.37	0.26	0.19
		L/300	5.91	2.49	1.28	0.74	0.47	0.31	0.22	0.16
1,00	8,61	*	11.45	7.12	4.86	3.53	2.69	2.11	1.70	1.40
		L/200	9.92	4.19	2.14	1.24	0.78	0.52	0.37	0.27
		L/250	7.94	3.35	1.71	0.99	0.62	0.42	0.29	0.21
		L/300	6.61	2.79	1.43	0.83	0.52	0.35	0.24	0.18
1,25	10,76	*	16.49	10.17	6.91	5.01	3.79	2.98	2.40	1.97
		L/200	12.01	5.07	2.59	1.50	0.95	0.63	0.44	0.32
		L/250	9.60	4.05	2.07	1.20	0.76	0.51	0.36	0.26
		L/300	8.00	3.38	1.73	1.00	0.63	0.42	0.30	0.22
1,50	12,91	*	22.03	13.52	9.15	6.60	4.99	3.91	3.14	2.58
		L/200	13.95	5.88	3.01	1.74	1.10	0.74	0.52	0.38
		L/250	11.16	4.71	2.41	1.39	0.88	0.59	0.41	0.30
		L/300	9.30	3.92	2.01	1.16	0.73	0.49	0.34	0.25

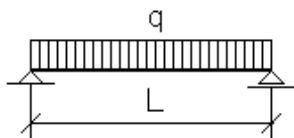

STEPRO B,eff

Oceľ S 320 GD

t	g	Kritérium pre	Medzné zaťaženie q [kN/m^2] pre rozpätie L [m]							
[mm]	[kg/m^2]	* pevnosť δ_{max}	0,75	1,00	1,25	1,50	1,75	2,00	2,25	2,50
0,40	3,44	*	3.95	2.35	1.51	1.05	0.77	0.59	0.46	0.38
		$L/200$	2.19	0.92	0.47	0.27	0.17	0.12	0.08	0.06
		$L/250$	1.75	0.74	0.38	0.22	0.14	0.09	0.06	0.05
		$L/300$	1.46	0.62	0.32	0.18	0.11	0.08	0.05	0.04
0,50	4,30	*	5.32	2.99	1.92	1.33	0.98	0.75	0.59	0.48
		$L/200$	2.76	1.17	0.60	0.35	0.22	0.15	0.10	0.07
		$L/250$	2.21	0.93	0.48	0.28	0.17	0.12	0.08	0.06
		$L/300$	1.84	0.78	0.40	0.23	0.15	0.10	0.07	0.05
0,60	5,16	*	6.32	3.55	2.27	1.58	1.16	0.89	0.70	0.57
		$L/200$	3.27	1.38	0.71	0.41	0.26	0.17	0.12	0.09
		$L/250$	2.62	1.11	0.57	0.33	0.21	0.14	0.10	0.07
		$L/300$	2.18	0.92	0.47	0.27	0.17	0.12	0.08	0.06
0,70	6,02	*	7.29	4.10	2.63	1.82	1.34	1.03	0.81	0.66
		$L/200$	3.77	1.59	0.81	0.47	0.30	0.20	0.14	0.10
		$L/250$	3.02	1.27	0.65	0.38	0.24	0.16	0.11	0.08
		$L/300$	2.51	1.06	0.54	0.31	0.20	0.13	0.09	0.07
0,75	6,46	*	7.77	4.37	2.80	1.94	1.43	1.09	0.86	0.70
		$L/200$	4.01	1.69	0.87	0.50	0.32	0.21	0.15	0.11
		$L/250$	3.21	1.35	0.69	0.40	0.25	0.17	0.12	0.09
		$L/300$	2.68	1.13	0.58	0.33	0.21	0.14	0.10	0.07
0,88	7,57	*	8.99	5.06	3.24	2.25	1.65	1.26	1.00	0.81
		$L/200$	4.63	1.95	1.00	0.58	0.36	0.24	0.17	0.13
		$L/250$	3.71	1.56	0.80	0.46	0.29	0.20	0.14	0.10
		$L/300$	3.09	1.30	0.67	0.39	0.24	0.16	0.11	0.08
1,00	8,61	*	10.09	5.68	3.63	2.52	1.85	1.42	1.12	0.91
		$L/200$	5.18	2.19	1.12	0.65	0.41	0.27	0.19	0.14
		$L/250$	4.15	1.75	0.90	0.52	0.33	0.22	0.15	0.11
		$L/300$	3.45	1.46	0.75	0.43	0.27	0.18	0.13	0.09
1,25	10,76	*	12.28	6.91	4.42	3.07	2.26	1.73	1.36	1.11
		$L/200$	6.27	2.65	1.35	0.78	0.49	0.33	0.23	0.17
		$L/250$	5.02	2.12	1.08	0.63	0.39	0.26	0.19	0.14
		$L/300$	4.18	1.76	0.90	0.52	0.33	0.22	0.15	0.11
1,50	12,91	*	14.35	8.07	5.17	3.59	2.64	2.02	1.59	1.29
		$L/200$	7.28	3.07	1.57	0.91	0.57	0.38	0.27	0.20
		$L/250$	5.83	2.46	1.26	0.73	0.46	0.31	0.22	0.16
		$L/300$	4.86	2.05	1.05	0.61	0.38	0.26	0.18	0.13

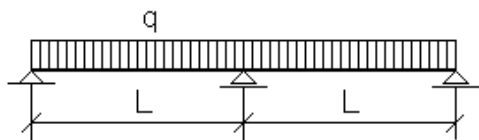

STEPRO B,eff

Oceľ S 320 GD

t	g	Kritérium pre	Medzné zaťaženie q [kN/m^2] pre rozpätie L [m]							
[mm]	[kg/m^2]	* pevnosť δ_{max}	0,75	1,00	1,25	1,50	1,75	2,00	2,25	2,50
0,40	3,44	*	1.85	1.15	0.79	0.57	0.43	0.34	0.27	0.23
		L/200	1.85	1.15	0.79	0.57	0.42	0.28	0.20	0.14
		L/250	1.85	1.15	0.79	0.53	0.33	0.22	0.16	0.11
		L/300	1.85	1.15	0.76	0.44	0.28	0.19	0.13	0.09
0,50	4,30	*	2.69	1.65	1.12	0.81	0.61	0.48	0.39	0.32
		L/200	2.69	1.65	1.12	0.81	0.52	0.35	0.25	0.18
		L/250	2.69	1.65	1.12	0.67	0.42	0.28	0.20	0.14
		L/300	2.69	1.65	0.96	0.56	0.35	0.23	0.16	0.12
0,60	5,16	*	3.62	2.21	1.49	1.07	0.81	0.63	0.51	0.42
		L/200	3.62	2.21	1.49	0.99	0.62	0.42	0.29	0.21
		L/250	3.62	2.21	1.36	0.79	0.50	0.33	0.23	0.17
		L/300	3.62	2.21	1.14	0.66	0.41	0.28	0.19	0.14
0,70	6,02	*	4.65	2.83	1.90	1.37	1.03	0.80	0.64	0.53
		L/200	4.65	2.83	1.90	1.14	0.72	0.48	0.34	0.25
		L/250	4.65	2.83	1.57	0.91	0.57	0.38	0.27	0.20
		L/300	4.65	2.56	1.31	0.76	0.48	0.32	0.22	0.16
0,75	6,46	*	5.20	3.15	2.12	1.52	1.14	0.89	0.72	0.59
		L/200	5.20	3.15	2.09	1.21	0.76	0.51	0.36	0.26
		L/250	5.20	3.15	1.67	0.97	0.61	0.41	0.29	0.21
		L/300	5.20	2.72	1.39	0.81	0.51	0.34	0.24	0.17
0,88	7,57	*	6.73	4.06	2.72	1.95	1.46	1.14	0.91	0.75
		L/200	6.73	4.06	2.41	1.40	0.88	0.59	0.41	0.30
		L/250	6.73	3.77	1.93	1.12	0.70	0.47	0.33	0.24
		L/300	6.73	3.14	1.61	0.93	0.59	0.39	0.28	0.20
1,00	8,61	*	8.25	4.96	3.31	2.37	1.78	1.38	1.11	0.91
		L/200	8.25	4.96	2.70	1.56	0.98	0.66	0.46	0.34
		L/250	8.25	4.22	2.16	1.25	0.79	0.53	0.37	0.27
		L/300	8.25	3.51	1.80	1.04	0.66	0.44	0.31	0.22
1,25	10,76	*	11.71	7.01	4.66	3.32	2.49	1.94	1.55	1.27
		L/200	11.71	6.38	3.27	1.89	1.19	0.80	0.56	0.41
		L/250	11.71	5.10	2.61	1.51	0.95	0.64	0.45	0.33
		L/300	10.08	4.25	2.18	1.26	0.79	0.53	0.37	0.27
1,50	12,91	*	15.48	9.22	6.11	4.35	3.26	2.53	2.02	1.65
		L/200	15.48	7.41	3.79	2.20	1.38	0.93	0.65	0.47
		L/250	14.05	5.93	3.03	1.76	1.11	0.74	0.52	0.38
		L/300	11.71	4.94	2.53	1.46	0.92	0.62	0.43	0.32

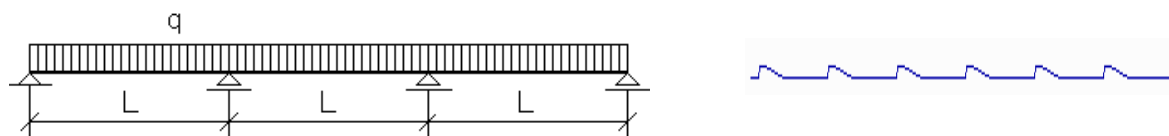

STEPRO B,eff

Oceľ S 320 GD

t	g	Kritérium pre	Medzné zaťaženie q [kN/m^2] pre rozpätie L [m]							
[mm]	[kg/m^2]	* pevnosť δ_{max}	0,75	1,00	1,25	1,50	1,75	2,00	2,25	2,50
0,40	3,44	*	2.60	1.68	1.18	0.88	0.68	0.54	0.44	0.37
		$L/200$	2.60	1.68	0.90	0.52	0.33	0.22	0.16	0.11
		$L/250$	2.60	1.41	0.72	0.42	0.26	0.18	0.12	0.09
		$L/300$	2.60	1.18	0.60	0.35	0.22	0.15	0.10	0.08
0,50	4,30	*	3.84	2.46	1.71	1.27	0.97	0.77	0.63	0.52
		$L/200$	3.84	2.23	1.14	0.66	0.42	0.28	0.20	0.14
		$L/250$	3.84	1.79	0.91	0.53	0.33	0.22	0.16	0.11
		$L/300$	3.53	1.49	0.76	0.44	0.28	0.19	0.13	0.10
0,60	5,16	*	5.27	3.34	2.31	1.70	1.30	1.03	0.84	0.69
		$L/200$	5.27	2.65	1.35	0.78	0.49	0.33	0.23	0.17
		$L/250$	5.02	2.12	1.08	0.63	0.39	0.26	0.19	0.14
		$L/300$	4.18	1.76	0.90	0.52	0.33	0.22	0.15	0.11
0,70	6,02	*	6.85	4.32	2.98	2.18	1.67	1.32	1.07	0.88
		$L/200$	6.85	3.05	1.56	0.90	0.57	0.38	0.27	0.19
		$L/250$	5.78	2.44	1.25	0.72	0.45	0.30	0.21	0.16
		$L/300$	4.81	2.03	1.04	0.60	0.38	0.25	0.18	0.13
0,75	6,46	*	7.69	4.84	3.33	2.44	1.86	1.47	1.19	0.98
		$L/200$	7.69	3.24	1.66	0.96	0.61	0.41	0.28	0.21
		$L/250$	6.15	2.59	1.33	0.77	0.48	0.32	0.23	0.17
		$L/300$	5.12	2.16	1.11	0.64	0.40	0.27	0.19	0.14
0,88	7,57	*	10.06	6.29	4.32	3.15	2.40	1.89	1.53	1.26
		$L/200$	8.87	3.74	1.92	1.11	0.70	0.47	0.33	0.24
		$L/250$	7.09	2.99	1.53	0.89	0.56	0.37	0.26	0.19
		$L/300$	5.91	2.49	1.28	0.74	0.47	0.31	0.22	0.16
1,00	8,61	*	12.44	7.75	5.30	3.85	2.93	2.31	1.86	1.53
		$L/200$	9.92	4.19	2.14	1.24	0.78	0.52	0.37	0.27
		$L/250$	7.94	3.35	1.71	0.99	0.62	0.42	0.29	0.21
		$L/300$	6.61	2.79	1.43	0.83	0.52	0.35	0.24	0.18
1,25	10,76	*	17.91	11.07	7.53	5.46	4.14	3.25	2.62	2.15
		$L/200$	12.01	5.07	2.59	1.50	0.95	0.63	0.44	0.32
		$L/250$	9.60	4.05	2.07	1.20	0.76	0.51	0.36	0.26
		$L/300$	8.00	3.38	1.73	1.00	0.63	0.42	0.30	0.22
1,50	12,91	*	23.95	14.71	9.97	7.20	5.45	4.27	3.43	2.82
		$L/200$	13.95	5.88	3.01	1.74	1.10	0.74	0.52	0.38
		$L/250$	11.16	4.71	2.41	1.39	0.88	0.59	0.41	0.30
		$L/300$	9.30	3.92	2.01	1.16	0.73	0.49	0.34	0.25

NORMY, LITERATÚRA:

- [1] ENV 1991-1-1 Eurokód 1: Účinky na konštrukcie. Časť 1-1: Zásady navrhovania a zaťaženia konštrukcií.
- [2] ENV 1991-1-1 Eurokód 1: Zaťaženia konštrukcií. Časť 1-1: Všeobecné zaťaženia. Objemová tiaž, vlastná tiaž a úžitkové zaťaženia budov.
- [3] ENV 1991-1-3 Eurokód 1: Zaťaženia konštrukcií. Časť 1-3: Všeobecné zaťaženia. Zaťaženia snehom.
- [4] ENV 1991-1-3 Eurokód 1: Zaťaženia konštrukcií. Časť 1-4: Všeobecné zaťaženia. Zaťaženia vetrom.
- [5] ENV 1993-1-1 Eurokód 3: Navrhovanie oceľových konštrukcií.
- [6] ENV 1993-1-3 Eurokód 3: Navrhovanie oceľových konštrukcií. Časť 1-3: Všeobecné pravidlá. Doplnkové pravidlá pre prúťové a plošné profily tvarované za studena.
- [7] SCHNEIDER, K.-J. a kol. : Bautabellen mit Brechnungshinweisen, Beispielen und europäischen Vorschriften. 10. Auflage 1992 Werner-Verlag
- [8] STUDNIČKA, J. a kol. : Zásady navrhování dle ENV 1993-1-1 (Eurokód 3) Praha, 1994.
- [9] STUDNIČKA, J. : Ocelové konstrukce 10. tenkostěnné profily. ČVUT Praha, 2002.
- [10] VRANÝ, T. - STUDNIČKA, J.: Tabulky pro návrh spojitě podepřených plechu VSŽ. Pozemní stavby 12-1990 s. 503-508.
- [11] WALD, F. a kol. : Prvky ocelových konstrukcí. Příklady podle Eurokódu, ČVUT, PRAHA, 1994.

PROGRAMY:

- [1] HUDÁK, J. - HUDÁK, I.: NOSNÍK - Statické riešenie spojitých nosníkov
- [2] HUDÁK, J. - HUDÁK, I.: PRIEREZY - Výpočet prierezových charakteristík tenkostenných prierezov